

The problem of resilience in multi-carrier cellular systems: responsibilities and regulation

Dr Graeme Hawker, Research Fellow
and Prof Keith Bell
Institute for Energy and Environment
University of Strathclyde



Infrastructure Transitions:
Resilience of Future
Energy Systems



Defining resilience

The ability to limit the extent, severity, and duration of system degradation following an extreme event

- An extreme event is one that is characterized by low frequency of occurrence, but having significant consequences
- Connected to, but separate from, the concepts of security and reliability
- The concept is intended to assist utilities and regulators to encourage prudent investments to enhance resilience capabilities of the interconnected power (energy) system

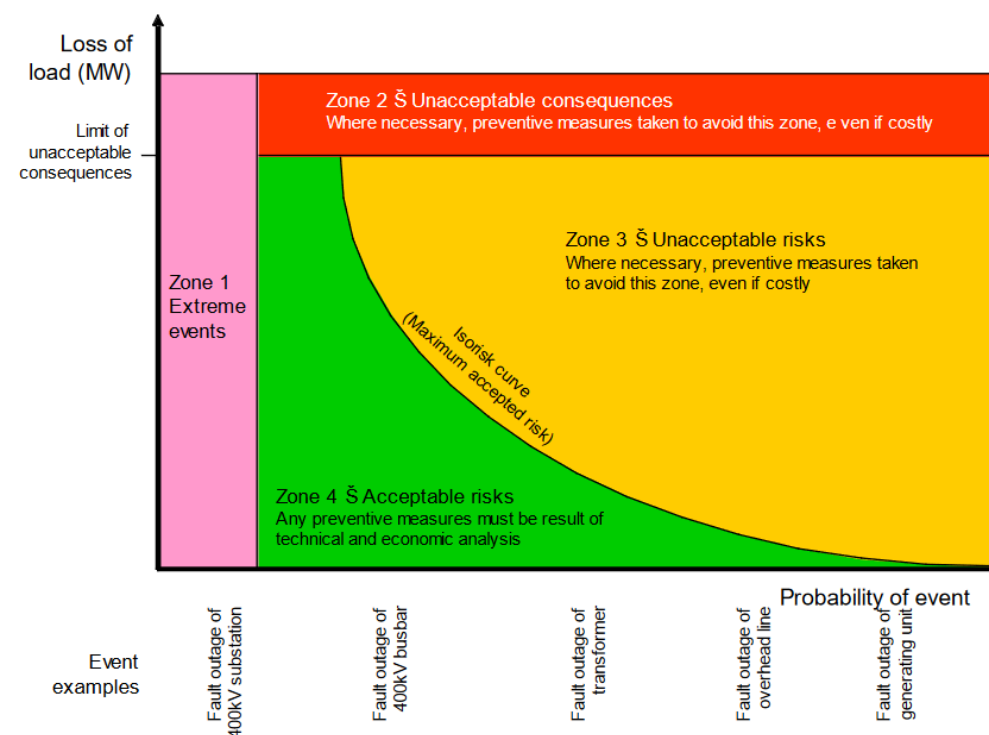

Major power system disruptions, 2018-20



Almost 1 million lose power after intense Halloween storm rolls through eastern US

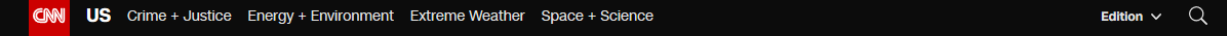

Power is almost fully restored after intentional shutoffs in Northern California left 800,000 in the dark

By Faith Karimi and Rebekah Riess, CNN
Updated 2200 GMT (0600 HKT) October 12, 2019

Spanish island of Tenerife suffers massive power outage

A Burning 13,000-Volt Cable Touched Off Manhattan Blackout, Con Edison Says

An equipment failure at a substation on the West Side of Manhattan plunged neighborhoods into darkness, the utility said.

Derecho damage: Rare storm leaves mass blackouts in Midwest

Dirty fuel, aging generators blamed for 13-hour blackout

Typhoon Faxai pounds Tokyo, leaving nearly 1 million people without power

Japan Starts to Restore Power After Quake Causes Record Blackout

AMERICAS-TEST-2 MARCH 8, 2019 / 12:19 PM / UPDATED 2 YEARS AGO

Venezuela power flickers after worst blackout in decades

Tens of millions in northern Brazil hit by massive power outage

Sri Lanka plunged into darkness as power outage hits entire nation

Power returning to Puerto Rico after massive outage caused by fallen tree

Power restored to some areas in Indonesia capital, parts of Java after 9 hours

'Massive Failure' in Power Grid Causes Blackout in Argentina and Uruguay

Massive blackout leaves more than 20,000 South Australian homes without power

MORE than 20,000 homes were left without power after wild weather ripped through South Australia — and the state is bracing for more.

Crippling blackout hits tens of millions in South America

NSW is 'state of extremes' hit with storms, snow and bushfires within days

Tens of thousands of Sydney homes are still without power this morning after a fast-moving storm of strong winds and hail lashed the city.

Forms of extreme event

- Weather-related: Texas February 2021
- Type failures: French nuclear fleet, 2016
- Independent simultaneous low-impact faults: Great Britain, 2008
- Wide-scale societal disruption: COVID-19



New failure modes for the energy system

Name	Description	Sector(s)	Timeline	Probability	Rate	Impact	Mitigating measures	Assessment methods
Electricity Network Failures	Ageing assets in the electricity system lead to more frequent failures and national/regional imbalances/instabilities	Electricity	Current	100%	Gradual	Brown/blackout	N-X security, asset replacement	Probabilistic metrics, SCOPF, Monte Carlo
Inertia / ROCOF	Increasing proportion of renewables in electricity mix reduces system's ability to absorb rapid changes in generation/demand balance (e.g. by a network or generator failure)	Electricity	2025+	90%	Gradual	Brown/blackout	Increasing reserve/response markets, capacity payments	Dynamic power system studies
Gas network failures	Ageing assets in the gas system lead to more frequent failures and national/regional imbalances/instabilities	Gas	Current	100%	Gradual	Industrial/residential interruption	Redundancy, asset replacement	Probabilistic metrics
Cross-sectoral couplings	Couplings between sectors (e.g. gas and electricity) compound impacts of failures	All	Current and increasing	90%	Gradual	Interruption to any energy services	Redundancy, asset replacement, comms between sectors, cross-sector security measures	Probabilistic whole-energy assessment
Flooding & coastal erosion	Increased erosion and water levels increase the intensity of flooding events, potentially affecting critical infrastructure	All	Current and increasing	100%	Gradual and instantaneous	Damage to energy assets and infrastructure	Flood and coastal defences	Climate change modelling, geophysical models
Extreme weather	Increased frequency of strong winds/icing causing failures in network assets	All	Current and increasing	90%	Instantaneous	Damage to energy assets and infrastructure	Engineering standards/lifetimes	Asset-specific destructive testing
Loss of skills & expertise	Shifts in job markets lead to energy system operators and asset owners unable to retain or recruit sufficient expertise to operate and maintain critical assets	All	2030+	30%	Gradual	Insecure operation, inability to commission new assets	Supply chain / job market protections, investment in HE/FE	Economic modelling
Political failure	Government's failure to appropriately maintain incentives or market rules leads to a failure of new investment	All	2025+	30%	Gradual	Interruption to any energy services	Long-term regulatory principles	Political science
International resource markets / geopolitics	Shifts in geopolitics reduce access to external primary resources (e.g. natural gas)	Gas	Current	80%	Near-instantaneous	Interruption to any energy services	Domestic energy security, bloc membership	Economic modelling
Outside Context Problem	Large-scale non-energy events which cannot be reasonably predicted or prepared for, but which have major impact on the energy system (e.g. CV19)	All	Any	Unknown	Instantaneous	Unknown	General resilience options	Horizon-scanning

Disaggregating resilience

Temporal dimensions:

- **Anticipation:** the ability to evaluate and monitor the onset of foreseeable scenarios that could have negative outcomes for the system
- **Preparation:** the deployment of measures ahead of a foreseen potential system event
- **Absorption:** the ability of a system to minimize or entirely avoid the consequences of an extreme event
- **Recovery:** in the event of adverse consequences, the ability of the system to return to a stable state which may be ready to manage the next such event
- **Adaptation:** the long-term response of the system to evolve and reduce the impact of future events in response to those experienced or avoided

Holistic dimensions:

- **Infrastructure resilience** – the physical strength and robustness of the system via long-term planning to withstand the impacts of an event
- **Operational resilience** – the short-term strength of the system through active management to ensure uninterrupted supply to customers
- **Organisational resilience** – the availability of staff and business continuity measures to ride through an event or crisis

Disaggregating resilience in the context of multiple carriers and decentralised cellular operation

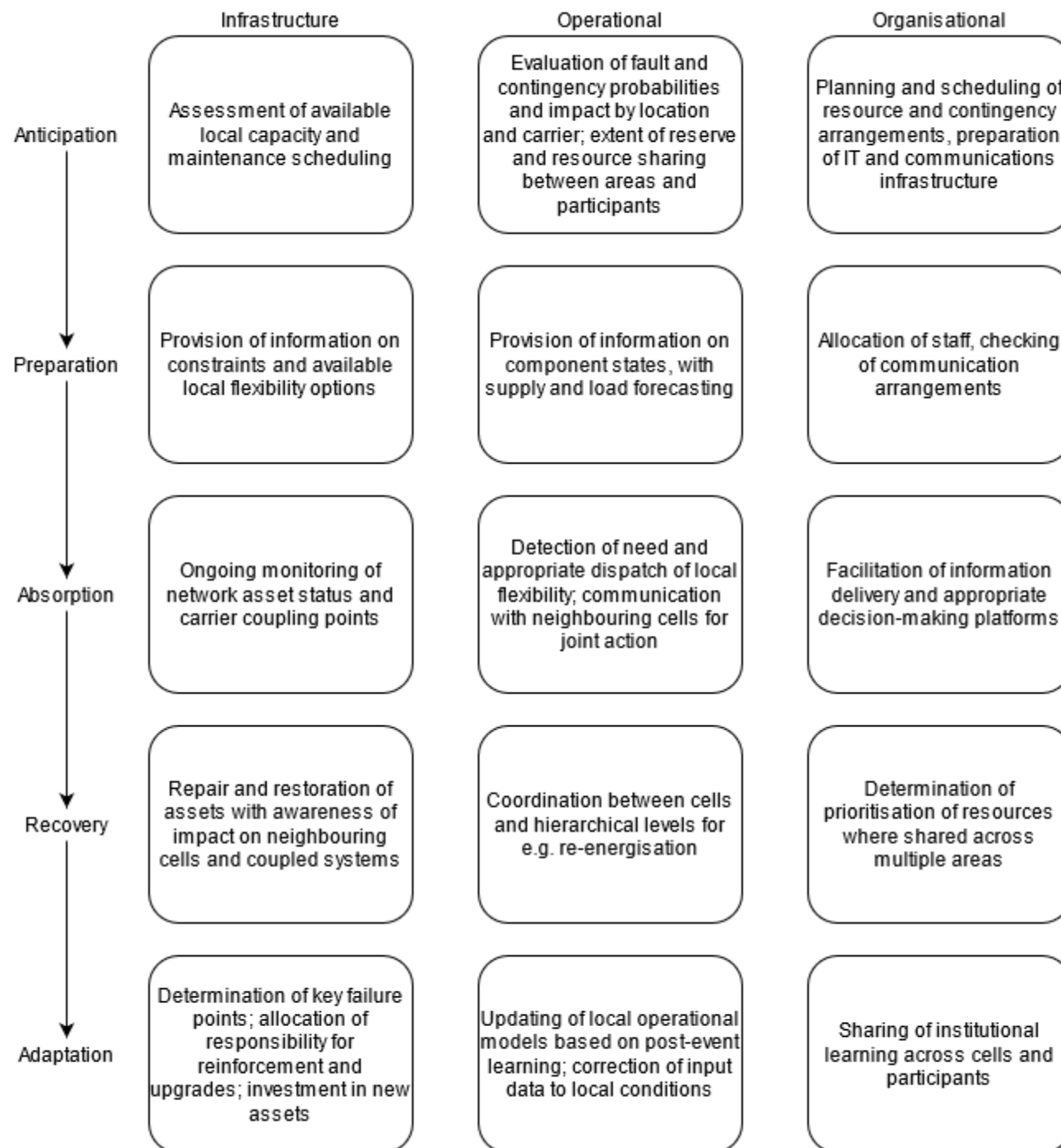

Assessing Stress Events

Event	Example	Input data
Extended wind lulls / ramping	Winter 2010	Reanalysis modelling; Future clustering scenarios
Type faults	Nuclear fleet; SCADA flaws/attacks	Market data – share by manufacturer/design; Common infrastructure
Weather-driven common mode failures	Sept 2011 – high wind shutdown ramping with low demand and distribution/comms outages	Temperature and wind reanalysis data + RCP pathways; GSP-level demand data; network failure rate statistics
Gas margins	Beast from the east 2018	Gas market/operational data

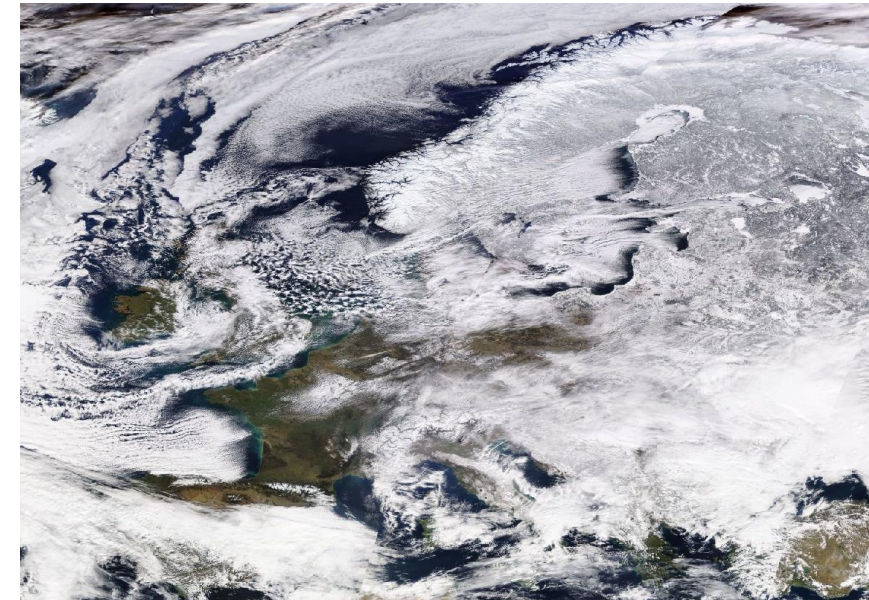

Determining duration; which techs can assist ride-through, how long before batteries discharge etc

Role of DSR – can it always be relied upon to assist during system stresses (consumer behaviour, comms)

Infrastructure and resilience



Price control

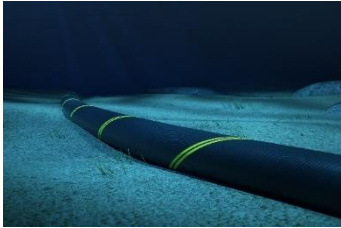

Cap and floor / CfDs



Open markets

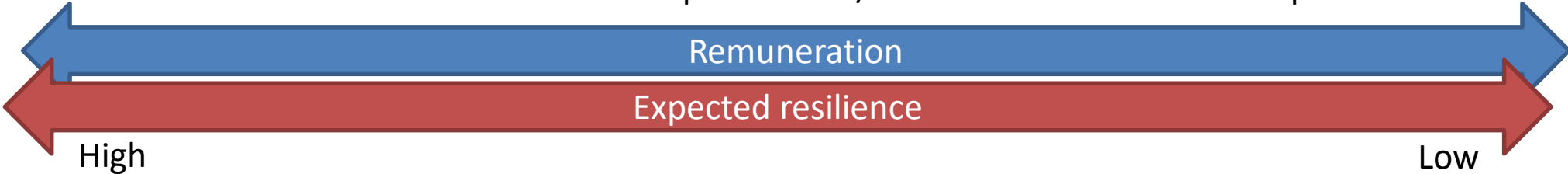

Solar capacity: 13092MW

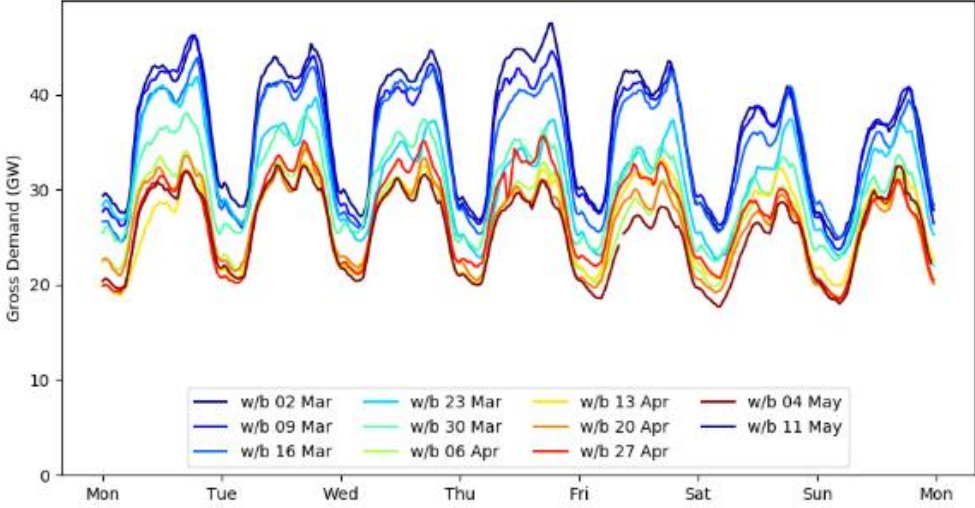
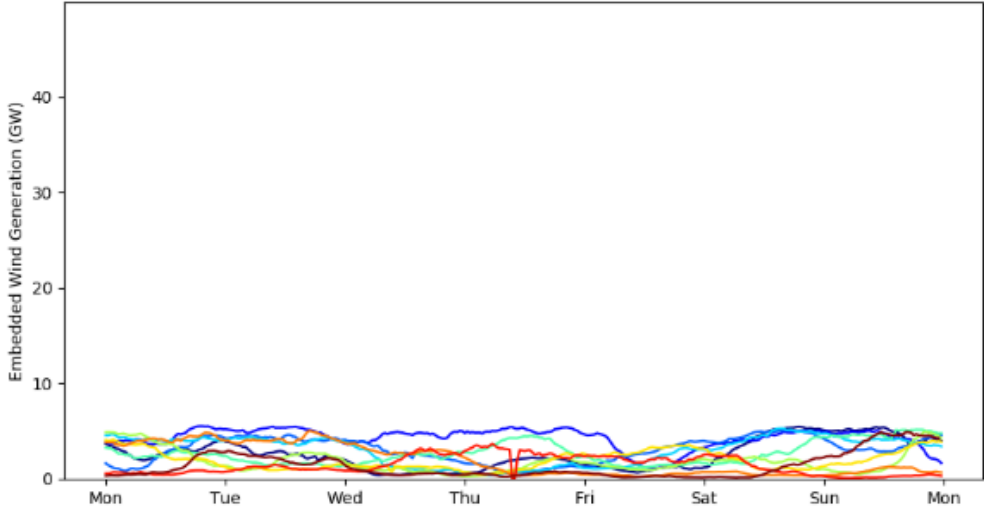
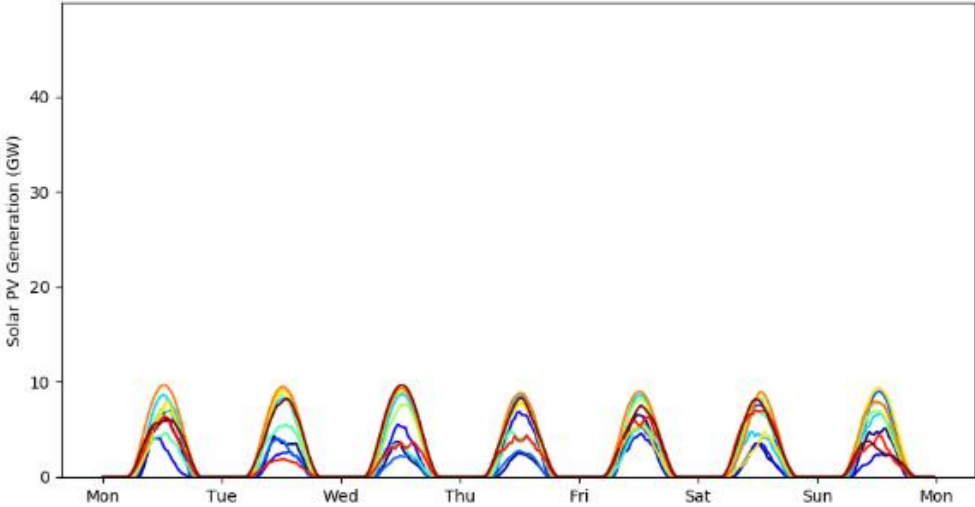
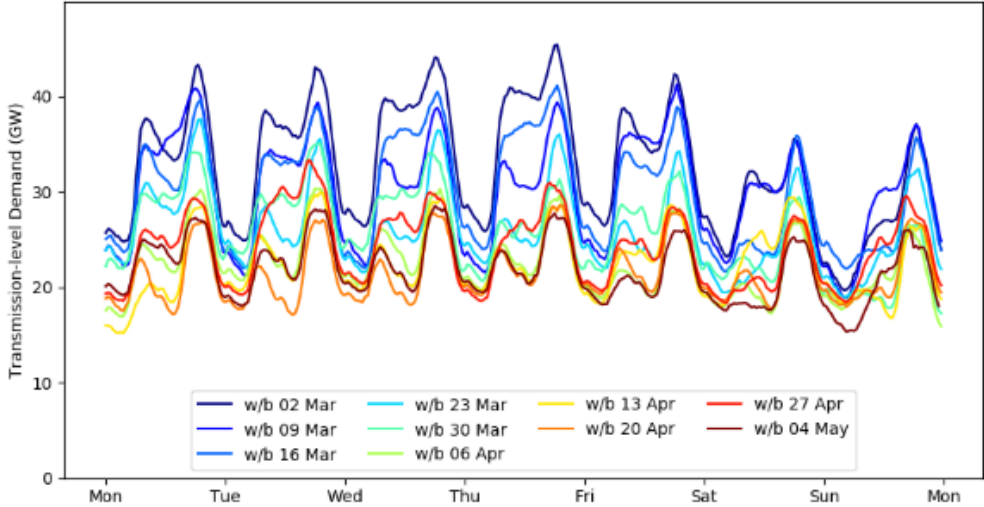

Embedded wind capacity: 6559MW

Mid-day minimum gross demand: 26376MW

Motivation for the Web-of-Cells concept

- Movement from transmission-connected dispatchable synchronous generators with downstream power distribution, to large number of small variable generators located at all voltage levels
- Generation following load, to load following generation
 - Active control of flexible loads and storage
- Increased amounts of distributed renewable energy systems
- Increasing electrical loads
- Grids used closer to their limits
 - Reverse power flows
 - Congestion
 - Voltage problems
 - Inefficiencies and losses
- Detect and solve local problems locally based on local observables:
 - Causes are highly distributed and local
 - Reserves providing resources can be local
 - Detailed local information is needed to activate securely and effectively
- Divide-and-conquer approach:
 - Secure and efficient decision in computationally tractable time
 - Mitigate communication and aggregation complexity, delays and risks

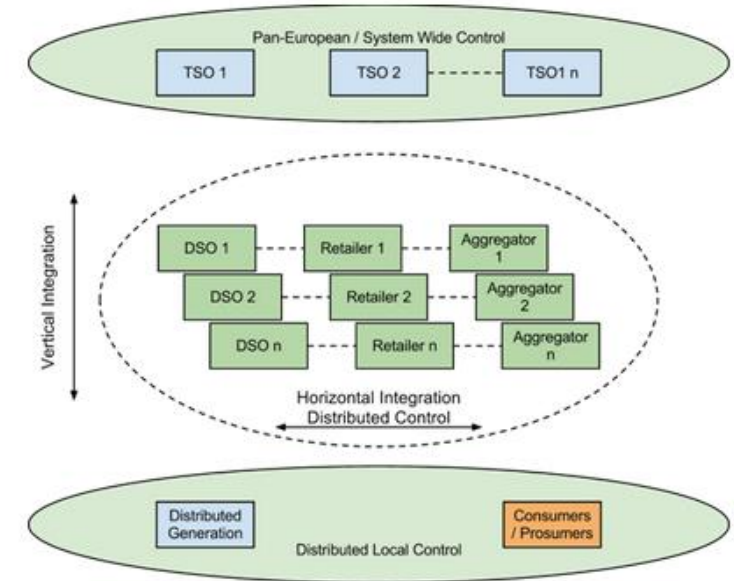

The Web-of-Cells (WoC) concept

A decentralised control scheme for reserve activation based on local observables, with local collaboration between cells based on local observables

- Within each cell, the total amount of internal flexibility is sufficient to compensate for the cell's generation and load uncertainties in normal operation
- Autonomous but collaborative management in a local grid-secure manner
- Each cell is managed by an automated Cell Controller (CC), under the responsibility of a Cell System Operator (CSO) that supervises its operation and, if required, overrides it
- Inter-cell connections can be radial or meshed, and can span multiple voltage levels

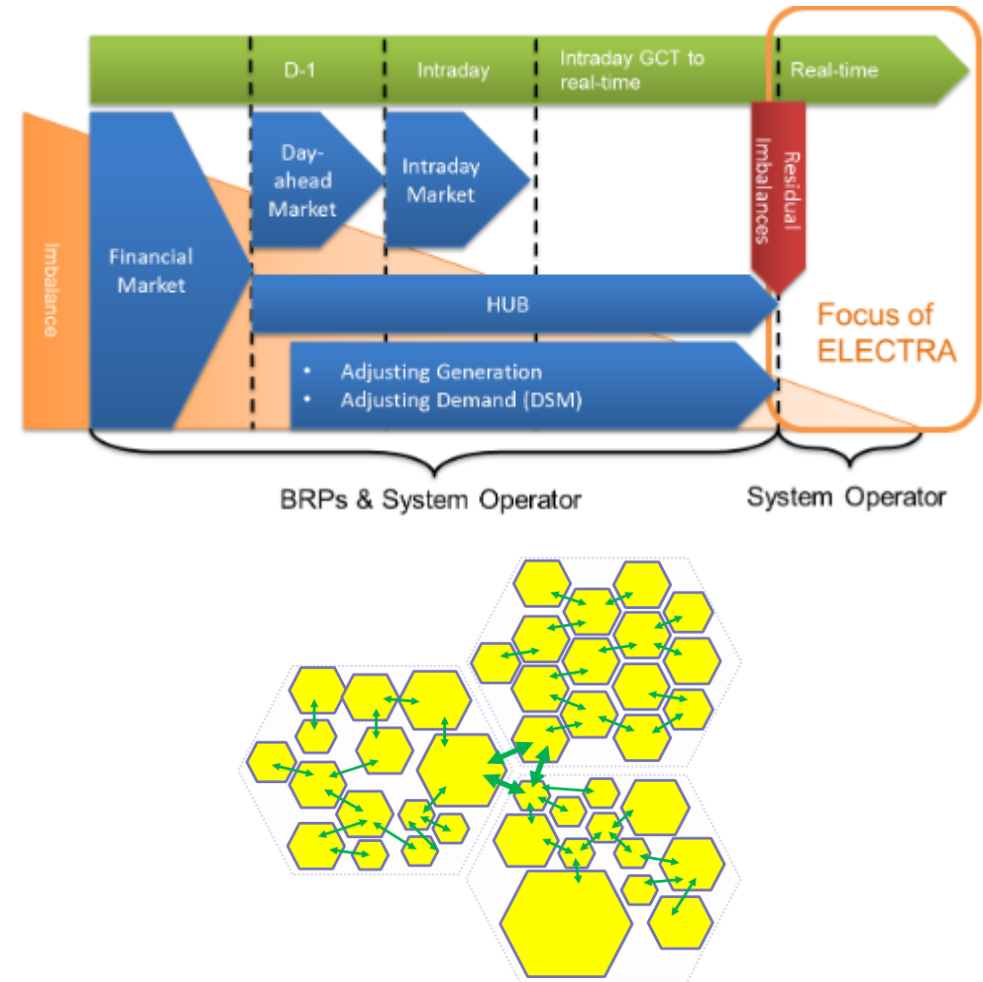

Cell control scheme

- Voltage control
 - Periodic proactive recalculation of voltage setpoints, optimising power flows for minimum losses
- Balance control
 - Decentralised bottom-up system balance restoration as aggregated effect of cell balance restoration

ELECTRA use case

Inertia Response Power Control
 Adaptive Frequency Containment Control
 Balance Restoration Control
 Balance Steering Control
 Primary Voltage Control
 Post-primary Voltage Control

Current control mechanisms (ENTSO)

-
 Frequency Containment Control
 Frequency Restoration Control
 Frequency Replacement Control
 Primary Voltage Control
 Secondary/Tertiary Voltage Control

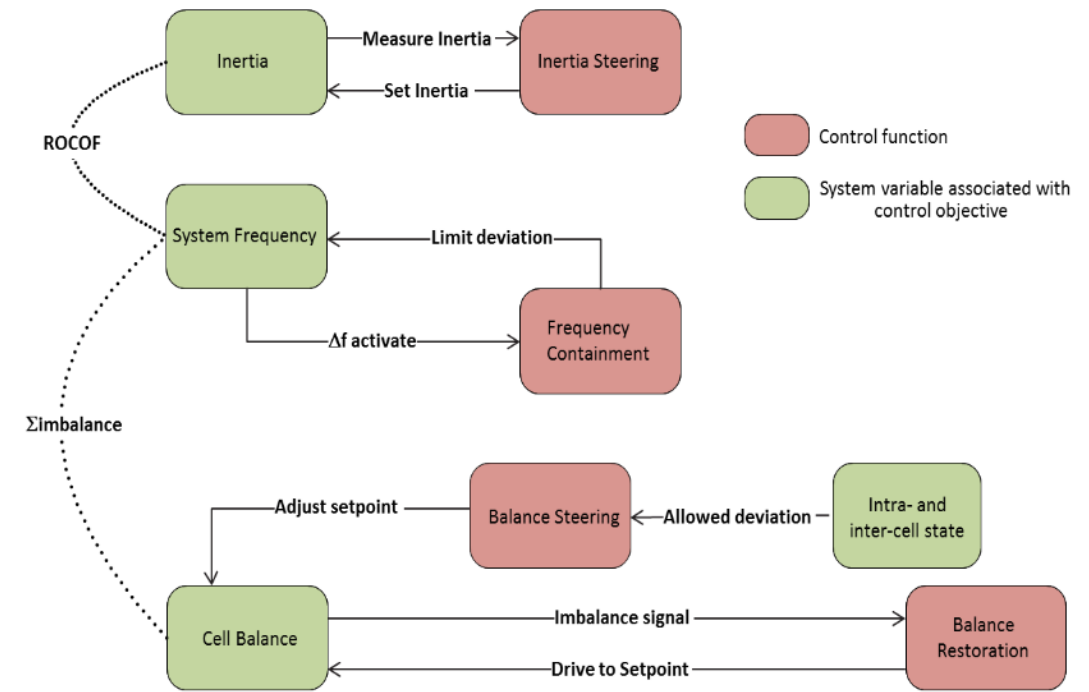
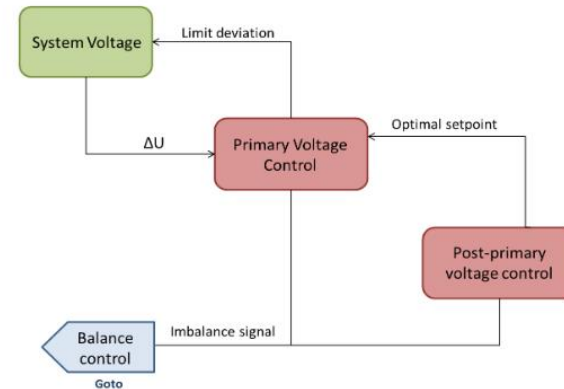

CSO responsibilities

- The CSO is responsible for:
 - Real-time reserve activation and dispatch within the cell;
 - Maintaining an accurate view of the overall cell state, and dispatching local reserves in a secure manner, based on their knowledge of the cell state;
 - Containing and restoring system frequency;
 - Containing local voltage within secure and stable limits.
- System Balance restoration = aggregated effect of (bottom-up) Cell Balance restoration
 - More activations (losing imbalance netting advantage), but
 - reducing losses (locality of correcting power flows)
 - increased security and more effective use of resources
- Enhanced resilience: ability to quickly dispatch and contain excursions within local cell
- Enhanced recovery: cell independently able to restore supply ahead of wider system

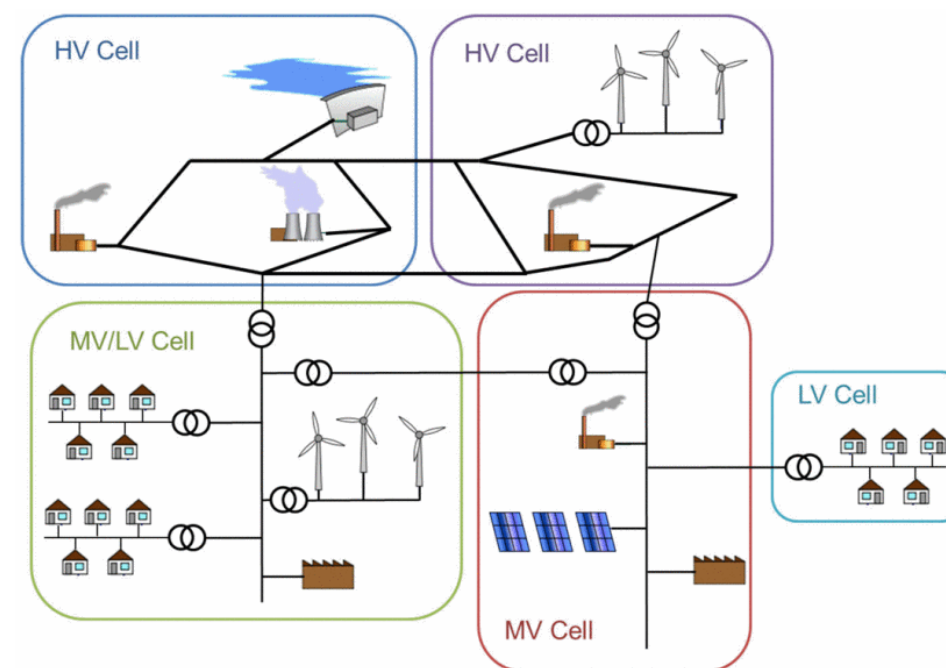

Extension to non-electrical carriers

- Fundamental local balancing principle can be used for non-electrical carriers
- Independent operation of cells creates opportunity for location-specific integration of hybrid assets
 - Bespoke market arrangements
 - CSOs can organise own contractual balancing services
- Enhanced resilience through increased capability to design load-balancing / disconnection arrangements

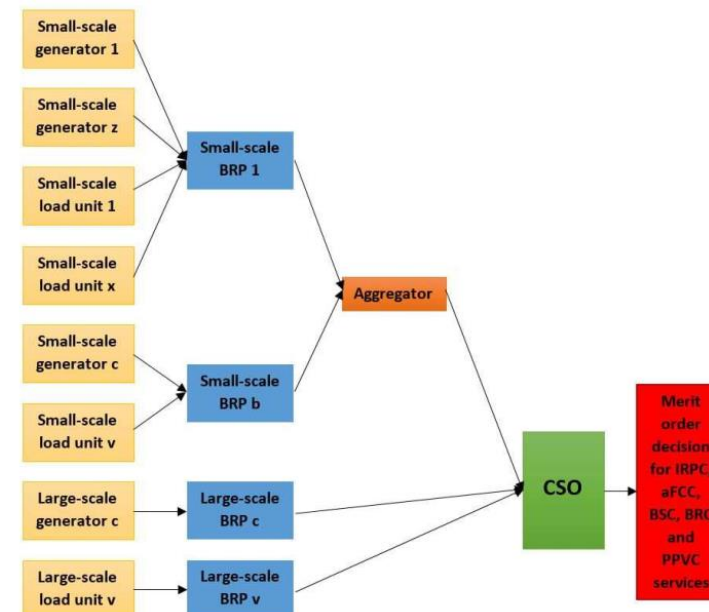

Regulatory principles

- Use of an 'anchoring' carrier (i.e. electricity) vs independent cells for each carrier
- Existing metrics (e.g. Value of Lost Load) do not take into account variance in value to end consumers of different carriers
 - Balanced view required to prioritise supply interruptions
 - Consolidation of different carrier timescales (e.g. gas disruption propagation)
- Organisational resilience is as important as infrastructure
 - Smaller organisational units reduces resource overhead
- Sharing of institutional knowledge – cells must be able to learn from each other's events and experiences
- Many failure modes for cellular and multi-carrier systems will not have been experienced yet
 - theoretical modelling is key for understanding resilience
 - Access to research data