

Simulation Methods for System Reliability Using the Survival Signature

Edoardo Patelli^{1,*}, Geng Feng¹, Frank P.A. Coolen², Tahani Coolen-Maturi³

¹*Institute for Risk and Uncertainty, University of Liverpool, Liverpool, United Kingdom*

²*Department of Mathematical Sciences, Durham University, Durham, United Kingdom*

³*Durham University Business School, Durham University, Durham, United Kingdom*

Abstract

Recently, the survival signature has been presented as a summary of the structure function which is sufficient for computation of common reliability metrics and has the crucial advantage that it can be applied to systems with components whose failure times are not exchangeable. The survival signature provides a huge reduction in required information, e.g. for its storage, compared to the full structure function, its implementation to larger systems is still difficult in a purely analytical manner and simulations may be required to derive the reliability metrics of interest. Hence, the main question addressed in this paper is whether or not the survival signature provides sufficient information for efficient simulation to derive the system's failure time distribution. We answer this question in the affirmative by presenting two algorithms for survival signature-based simulation. In addition, we present a third simulation algorithm that can be used in case of repairable components. It turns out that these algorithms are very efficient, beyond the initial advantage of requiring only the survival signature to be available, instead of the full structure function.

Keywords: Reliability Analysis; Survival Signature; Monte Carlo Method; Complex Systems; Multi state components.

1. Introduction

The study of the reliability of complex systems, particularly systems with a structure that cannot be sequentially reduced by considering alternative series and parallel subsystems, is a topic subject which has attracted much attention in

*Corresponding author

Email address: edoardo.patelli@liverpool.ac.uk (Edoardo Patelli^{1,*})

5 the literature and which is of obvious importance in many application areas [1].
Traditionally, the reliability analysis of systems is performed adopting different
well-known tools such as reliability block diagrams, fault tree and success tree
methods, failure mode and effect analysis, and master logic diagrams [2]. The main
10 limitation of these traditional approaches for applicability to large complex systems
is due to the complex and tedious calculations for finding minimal path sets and
cut sets. For instance, for a system with m components 2^m combinations of
component states must be specified, which is impossible for most practical systems
and networks. Instead, if the systems components can be divided into groups with
exchangeable failure times, the survival signature is sufficient to derive the systems
15 failure time distribution given the components failure time distributions.

In addition, when the information about the system is not perfect, for example
leading to imprecise probabilities being required to quantify the uncertainties, it
is even more difficult to apply those methods.

In recent years, the system signature has been recognized as a useful tool to
20 quantify the reliability of systems consisting of independent and identically dis-
tributed (*iid*) or exchangeable components with respect to their random failure
times [3, 4], we say that such systems only have ‘components of one type’. The
system signature enables full separation of the system structure from the compo-
nent probabilistic failure time distribution when deriving the system failure time
25 distribution. However, attempting to generalize the system signature to systems
with more than one component type is not really possible as it requires the compu-
tation of the probabilities of different orderings of order statistics of the different
failure time distributions involved [5], which tends to be intractable.

In order to overcome the limitations of the system signature, Coolen and
30 Coolen-Maturi [5, 6] presented the survival signature, which has the same merits
as the system signature for systems consisting of a single type of components, but
it is also an effective tool for analysing complex systems consisting of multiple
component types. Therefore, the survival signature is a useful tool for reliability
quantification for complex systems and networks because it only needs to be calcu-
35 lated once providing a massive reduction of the computational cost required by the
analysis. Recently, Coolen et al. [7] presented non-parametric predictive inference
for system reliability using the survival signature, and Aslett et al. [8] did similarly
within the Bayesian framework of statistics. Feng et al. [9] developed an analytical
method to calculate the survival function of systems with uncertainty about pa-
40 rameters of assumed component failure time distributions. These methods are all
useful, but may become less practical for larger complex systems. System survival
signature can also be derived from subsystems’ survival signatures, if these are in

series-parallel configurations [7]. Recently, Reed presented an efficient computational approach for computing exact system and survival signatures of large and complex systems [10]. The survival signature together with the provided simulation algorithms provides a generalized tool for realistic quantification of system reliability.

Parameter uncertainties and imprecisions are generally epistemic in nature due to the lack of knowledge or data, or the unknown relationship between components (e.g., poor understanding of accident initiating events or coupled physics phenomena, lack of data to characterise experiment processes, random errors in measuring and analytic devices), all of them make it difficult to characterize probabilistically the failure time of components. Since the reliability and performance of systems are directly affected by uncertainties and imprecisions, a quantitative assessment of uncertainty is widely recognized as an important task in practical engineering [11, 12].

Simulation approaches are used to investigate large and complex systems and for obtaining numerical solutions where analytical solutions are not available. In particular, simulation methods allow to consider explicitly the effect of uncertainty and imprecision on the system under investigation providing a powerful tool for risk analysis which allows better decision making under uncertainty. Simulation method can be used to e.g. identify problems before implementation, evaluate ideas and identify inefficiencies, understand why observed events occur.

The use of simulation methods for system reliability has many attractive features. Generally, it can be used for the sensitivity analysis of multi-criteria decision model [13], optimize models with rare events [14] and perform multi-attribute decision making [15]. Most of the current simulation methods are based on Monte Carlo simulation and structure function. By generating the state evolution of each component, the structure function is computed to determine the state of the system. The structure function is in a boolean format and can only be used to identify a specific output of the system. More structure functions can be used to match all the possible status of the system at the cost of increasing the complexity of the analysis (see e.g. [16]). Several methods are available for the reliability analysis of complex system based on structural function (see e.g. [17, 4, 18]). However, we envisage a scenario, particularly for large systems, where the full system structure information (or structure function, min paths sets etc.) is not available but only the survival signature that represents a summary of the structure function. In particular, for very large scale systems and networks, storing only the survival signature and not the entire structure function is clearly advantageous.

In this paper, we will show that the survival signature is sufficient for basic

reliability inferences (e.g. determining the system reliability function) which can be used for further inferences and decision support. Efficient simulation approaches are proposed to estimate the reliability of systems based on survival signature. The method is particularly useful when the probability term of the survival function (as shown later in the Eq. 2 representing the probability of the components working at specific time), cannot easily be derived analytically but the failure times for the exchangeable components can nevertheless be sampled through simulation.

The proposed simulation approaches are generally applicable to any system configuration. In addition, it allows to consider different representation of the uncertainties including system multi-state components (i.e. repairable components). The numerical implementation of the proposed approaches is based on two open source packages: the R package “ReliabilityTheory” [19, 20] adopted to calculate the survival signature and OpenCossan [21, 22] a Matlab toolbox for uncertainty quantification and reliability analysis used to simulate the system evolution. The applicability and efficiency of the proposed approaches are demonstrated by solving numerical examples.

This paper is organized as follows. Section 2 presents a brief overview of the survival signature and the related system survival function. Survival signature-based simulation methods for system reliability are presented in Section 3. In Section 4, the applicability and performance of the proposed approaches is shown by analysing four numerical examples. Finally Section 5 closes the paper with conclusions.

2. Survival Signature

Suppose there is one system consisting of m components. Let the state vector of components be $\underline{x} = (x_1, x_2, \dots, x_m) \in \{0, 1\}^m$ with $x_i = 1$ if the i th component is in working state and $x_i = 0$ if not. $\phi = \phi(\underline{x}) : \{0, 1\}^m \rightarrow \{0, 1\}$ defines the system structure function, i.e., the system status based on all possible \underline{x} . ϕ is 1 if the system functions for state vector \underline{x} and 0 if not.

Now consider a system with $K \geq 2$ types of M components, with m_k indicating the number of components of each type and $\sum_{k=1}^K m_k = M$. It is assumed that the failure times of the components of the same type are independently and identically distributed (*iid*) or exchangeable. Note that this is usually understood as implying that the components are ‘exchangeable’, e.g. produced by the same manufacturer. However, the assumed exchangeability of their failure times also implies a similarity of the tasks the components of the same type perform in the system, e.g. if similar components function at different stress levels their failure time distributions are likely not to be the same and hence for the reliability analysis using the survival signature such components would be considered to be of different types. The

components of the same type can be grouped together because of the random
120 ordering of the components in the state vector, which leads to a state vector can be
written as $\underline{x} = (\underline{x}^1, \underline{x}^2, \dots, \underline{x}^K)$, with $\underline{x}^k = (x_1^k, x_2^k, \dots, x_{m_k}^k)$ representing the states
of the components of type k . Coolen and Coolen-Mature [5] introduced the survival
signature for such a system, denoted by $\Phi(l_1, l_2, \dots, l_K)$, with $l_k = 0, 1, \dots, m_k$ for
 $k = 1, 2, \dots, K$, which is defined to be the probability that the system functions
125 given that l_k of its m_k components of type k work, for each $k \in \{1, 2, \dots, K\}$.
There are $\binom{m_k}{l_k}$ state vectors \underline{x}^k with precisely l_k components x_i^k equal to 1, so
with $\sum_{i=1}^{m_k} x_i^k = l_k$ ($k = 1, 2, \dots, K$), and S_{l_1, l_2, \dots, l_K} denote the set of all state
vectors for the whole system.

Assume that the random failure times of components of the different types are
130 fully independent, and in addition the components are exchangeable within the
same component types, then the survival signature is equal to:

$$\Phi(l_1, \dots, l_K) = \left[\prod_{k=1}^K \binom{m_k}{l_k}^{-1} \right] \times \sum_{\underline{x} \in S_{l_1, l_2, \dots, l_K}} \phi(\underline{x}), \quad (1)$$

where $C_k(t) \in \{0, 1, \dots, m_k\}$ is the number of k components working at time t . The
survival function of the system with K types of components can be expressed as
[5]:

$$P(T_S > t) = \sum_{l_1=0}^{m_1} \dots \sum_{l_K=0}^{m_K} \Phi(l_1, \dots, l_K) P\left(\bigcap_{k=1}^K \{C_k(t) = l_k\}\right) \quad (2)$$

135 If one can assume that the components of the same type have a known CDF, $F_k(t)$
for type k , and that the failure times of different component types are independent,
then these expressions are simplified using [5]:

$$P\left(\bigcap_{k=1}^K \{C_k(t) = l_k\}\right) = \prod_{k=1}^K P(C_k(t) = l_k) = \prod_{k=1}^K \binom{m_k}{l_k} [F_k(t)]^{m_k - l_k} [1 - F_k(t)]^{l_k} \quad (3)$$

Equation (2) separates the structure of the system from the failure time distri-
bution of its components, which is the main advantage of the survival signature,
140 which it shares with the system signature. The survival signature only needs to
be calculated once for any system, which is similar to the system signature for
systems with only single type of components. The survival signature is closely
related with system signature. For a special case of a system with only one type
($K = 1$) of components, the survival signature and the system signature [3] are
145 directly linked to each other through a simple equation, however, the latter cannot

be easily generalized for systems with multiple types ($K \geq 2$) of components [5].

This implies that all attractive properties of the system signature also hold for the method using the survival signature. The survival signature is easy to apply for systems with multiple types of components, and one could argue it is much easier to interpret than the system signature. In addition, the quite simple survival signature (in particular for large systems with only relatively few different component types) and its monotonicity for coherent systems provide clear advantages to work towards approximations of the system reliability metrics. This does not limit the applicability of the survival signature to non-coherent systems (for example, electric distribution network or part of the electronic equipment of safety features). In such cases, the analysis of system with imprecision in the component failure time requires a full “double loop” approach as detailed in Section 3.4.

3. Simulation Methods

Exact analytical solution can be obtained from Eq. 2 and Eq. 3. However, analytical solutions are restricted to particular cases (e.g. system with component failure time following exponential distribution and not repairable components). Instead, simulation methods can be applied to study and analyse any systems without introducing simplifications or unjustified assumptions.

The survival signature presented in the previous section can be adopted in a Monte Carlo based simulation method to estimate the system reliability in a simple and efficient way. A possible system evolution is simulated by generating random events (i.e. the random transition such as failure times of the system components) and then estimating the status of the system based on the survival signature (Equation 3). Then, counting the occurrence number of a specific condition (e.g. counting how many times the system is in working status), it is possible to estimate the reliability of the system. In this section, three Monte Carlo simulation methods adopting the survival signature are presented. The Algorithms 1 and 2 are used to estimate the reliability of non-repairable systems while Algorithm 3 can be applied for repairable systems and multi-state components as well.

3.1. Algorithm 1

The first simulation method is based on the realizations of failure events of the system’s components. For each failure event the status of the system is generated based on the probability that the system is working knowing that a specific number of components are working. Such probability is given by the survival signature as defined in Equation (1). The survival signature is computed only once before starting the Monte Carlo simulation for instance using the approach presented in [10]. Suppose there is a system with C components, K component types and m_k

components of type k . Hence, $C = \sum_{k=1}^K m_k$. We assume that components of type
185 k have the same failure time distribution and that there is no repair opportunity
for the components. The reliability of the system can be estimated adopting the
following procedure:

- Step 0. Initialise variables and counters (i.e. Vr);
- Step 1. Sample the failure times for each component, f_i , for $i = 1, 2, \dots, C$. The
190 failure time of a component of type k is obtained by sampling from the
corresponding CDF F_k ;
- Step 2. Order the sequence of failure times $t_i \leq t_{i+1}$ for $i = 1, 2, \dots, M$. Hence, t_1
represents the first failure of a system component, t_2 represents the second
failure and so on;
- 195 Step 3. At each failure time, it is easy to calculate the number of components
working for each component type: $C_k(t_i)$;
- Step 4. Evaluate the survival signature which applies immediately after the cor-
responding failure indicated as $\Phi_{t_i} \equiv \Phi(C_1(t_i), C_2(t_i), \dots, C_K(t_i))$;
- Step 5. Drawn from a Bernoulli distribution with probability $1 - \Phi_{t_1}$ the system
200 status X_1 at time t_1 , if $X_1 = 1$ the system fails;
- Step 6. If the system does not fail at t_1 , then consider t_2 . The probability that
the system functions at time t_2 is $\Phi_{t_2}/\Phi_{t_1} = q_2$, given that it has survived
at time t_1 . So the system failure at time t_2 , X_2 , is drawn from a Bernoulli
distribution with the probability $1 - q_2$;
- 205 Step 7. Repeat Step 6 to process other failure times: Set $i = i + 1$.
- Step 8. Store the status of the system over the time, as follows: $Vr(j) = Vr(j) +$
 $1 \quad \forall j : j \cdot dt < t_f$ where t_f is the system failure time and dt represents
the discretisation time.

The above procedure is repeated for N samples and the estimate of the survival
210 function is obtained by averaging the vector collecting the status of the system
over the number samples: $P(T_s > t) \approx \frac{Vr(t)}{N}$.

This method simulates one system failure time in each run (Steps 1-7). It
should be noted that with the assumption that the system fails if no component
functions, this implies that there is an i^* , less than or equal to C , such that $q_{i^*} = 0$.
215 Hence the system fails certainly at this t_{i^*} if it has not failed before.

A pseudo-algorithms of the simulation method is shown in Algorithm 1.

3.2. Algorithm 2

It is possible to estimate the system reliability without the necessity to sample
the system status at each component failure time. The idea is to interpret the
220 survival signature as a normalised “production capability” of the system defined

by the Equation (1). For instance, if all the components are working, the system output is 1. If all components are in failure status, the system output is 0. Hence, instead of sampling the system state at each failure time, the survival signature is evaluated to collect the “production level of the system”, i.e. the survival signature is evaluated immediately after each sampled component failure time and collected in proper counters. This can be obtained adopting the Algorithm 2 derived from the approach proposed by one of the authors used to estimate the production availability of an offshore installation requiring the derivation of the complete status of the system (based on the structural function and cut-sets) [16]. Here, a novel algorithm is proposed to estimate the reliability adopting the survival signature and hence avoiding the tedious calculation of all the system status.

The reliability of the system can be estimated modifying the Steps 5-7 of the Algorithm 1 as follows:

Step 5'. Compute the production level of the system by evaluating the survival signature at each time of interest Φ_{t_i} . The probability that the system survives time t_1 is Φ_{t_1} ;

Step 6'. Collect the value of the survival signature in the vector Vr representing the survival function as follows: $Vr(j) = Vr(j) + \Phi_{t_i} \quad \forall j : j \cdot dt < t_i$ where dt represents the discretization time.

The above procedure is repeated for N samples and the reliability of the system is computed by averaging the values of the survival signature: $P(T_s > t) \approx \frac{1}{N} Vr(t)$. The uses of the survival signature makes this approach extremely efficient since it does not require to sample the system output at each component transition time (i.e. component failures). For each Monte Carlo simulation, this method generates a random grid of time points at which to evaluate the survival signature representing the survival probability of the system at those times. Finally, the survival function is obtained by directly averaging the survival signature over the time.

A pseudo-algorithms of the simulation method for non-repairable components is shown in Algorithm 2 and the flow chart of the simulation methods proposed for estimate the reliability of non-repairable systems is shown in Figure 1a.

Algorithm 2 follows the productivity idea, which gives each run a possible survival function while Algorithm 1 gives a single system failure time in each run. Therefore, Algorithm 1 is useful for inference where one explicitly wants the simulated system failure times, whilst Algorithm 2 is efficient for inference on the system survival function.

It can be shown that the variance of the survival function estimator at each

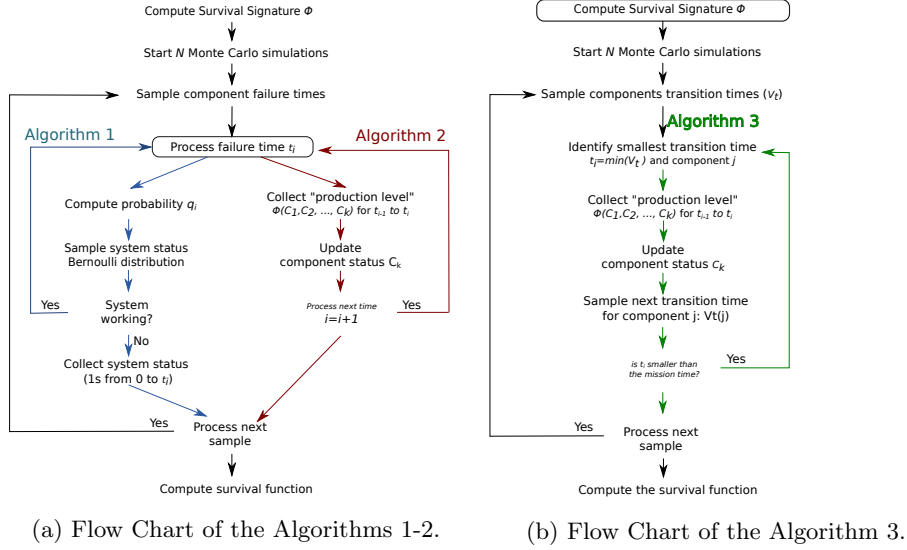

Figure 1: Flow Chart of the proposed algorithms.

time of interest obeys to the following formula [23]:

$$Var[Vr(t)] \approx \frac{1}{N} \left(\overline{Vr^2(t)} - \overline{Vr(t)}^2 \right) \quad (4)$$

where N represents the number of samples and $\overline{Vr^2(t)}$ the mean of the square values of the survival function at time t and $\overline{Vr(t)}^2$ the square of the mean values of the survival function at time t . Also, in Equation (4) it is common to substitute $N - 1$ in place of N although the correction is negligible because $N \gg 1$. The Algorithm 2 tends to lead to better estimates of the system reliability when compared to Algorithm 1, as detailed in Section 4.1 and shown in Figure 5.

3.3. Algorithm 3

Algorithm 2 can easily be extended to analysing systems with multi-state components such as repairable systems. Assume that there are j_k possible transitions for the components of type k . The probability of going from state $s = l$ to state $s' = m$ in given by $p_{klm} = \Pr(X_k = m | X_k = l)$. Let $F_{kl} = \sum_m \Pr(X_k = m | X_k = l) = \Pr(\cdot | X_k = ;)$ represents the CDF of the component of type k to exit from its state l , i.e. to undergo a transition leading to a state $m \neq l$.

Let assume for the moment that there is only one possible transition to exit from the state $s = l$. For instance, a component in working status $s = 1$ can fail and entering in the state $s' = 2$; the component in the state $s = 2$ can only be repaired and returning in the status $s' = 1$. Hence, $p_{k21} = \Pr(X_k = 2 | X_k = 1) = p_{k2}$

represents the probability of failure for component k , $p_{k12} = p_{k1}$ the probability
 275 of repair. The Monte Carlo simulation is performed as follows.

- Step 0. Initialise variables (i.e. $t_{old} = 0$) and counters (i.e. Vt);
- Step 1. Sample the transition times t_i for $i = 1, 2, \dots, C$ for each component
 of the system from the corresponding CDF, F_{kl} , and stored in a vector
 $Vt = \{t_1, t_2, \dots, t_M\}$, set $t_{old} = 0$;
- 280 Step 2. Identify the first transition time, i.e. $\min(Vt)$ and the corresponding
 component z . Hence, t_1 represents the first transition of the system, t_2
 the second transition and so on;
- Step 3. At each transition time t_i , calculate the number of components in work-
 ing status (i.e. $C_{t_i} = (C_1, C_2, \dots, C_K)$). The corresponding “production
 285 level” Φ_{t_i} is obtained by evaluating the survival signature for the number
 of components in working status;
- Step 4. Collect the value of the survival signature at time t_i , Φ_{t_i} , in a counter Vr
 representing the survival function as follows: $Vr(j) = Vr(j) + \Phi_{t_i} \quad \forall j :$
 $t_{old} \leq j \cdot dt < \min(Vt)$.
- 290 Step 5. Set $t_{old} = \min(Vt)$ and sample the new status of the component z from
 the probability mass function $P(s = m) = \frac{F_{klm}(t_i)}{F_{kl}(t_i)}$;
- Step 6. Update the vector of transition time Vt by sampling the next transition
 time t'_z of the component z of type k in status m from F_{km} . Hence:
 $Vt(z) = t_z + t'_z$;
- 295 Step 7. If $\min(Vt) < T_F$ (i.e. the final time), return to point 2.

The above steps are repeated for N samples and the survival function obtained by
 averaging the vector Vr over the number of samples. The flow chart of the pro-
 posed algorithm is shown in Figure 1b and the pseudo-code is shown in Algorithm
 3.

300 3.4. Reliability analysis of systems with imprecision

Reliability analysis of complex systems requires the probabilistic characteri-
 zation of all the possible component transitions. This usually requires a large
 data-set that is not always available. In fact, it might not be possible to unequiv-
 ocially characterize some component transitions due to lack of data or ambiguity.
 305 To avoid the inclusion of subjective knowledge or experts opinions, the impre-
 cision and vagueness of the data can be treated by using concepts of imprecise
 probabilities.

Imprecise probability combines probabilistic and set theoretical components
 in a unified construct (see e.g. [24, 25, 26]). It allows a rational treatment of
 310 the information of possibly different forms without ignoring significant informa-
 tion, and without introducing unwarranted assumptions. For instance, if only few

data points are available it might be difficult to identify the parameters and the form of a distribution [27]. An unknown value of a (deterministic) parameter is often modelled using a uniform distribution based on the principle of maximum entropy should be model as interval and not as distribution [28, 29]. In the analysis, imprecise probabilities combine, without mixing, randomness and imprecision. Randomness and imprecisions are considered simultaneously but viewed separately at any time during the analysis and in the results. The probabilistic analysis is carried out conditional on the elements from the sets, which leads eventually to sets of probabilistic results, see e.g. [30, 31, 32, 33]).

Considering the imprecision in the component parameters will lead to bounds of survival function of the systems and it can therefore be seen as a conservative analysis, in the sense that it does not make any additional hypothesis with regard to the available information. In some instances analytical methods will not be appropriate means to analyse a system. Again, simulation methods based on survival signature can be adopted to study systems considering parameter imprecision. A naive approach consists in adopting a double loop sampling where the outer loop is used to sample realization in the epistemic space. In other words, each realization in the epistemic space defines a new probabilistic model that needs to be solved adopting the simulation methods proposed above. Then the envelop of the system reliability is identified. However, since almost all the systems are coherent (system is coherent if each component is relevant, and the structure function is non decreasing), it is only necessary to compute the system reliability twice, using the lower and upper bounds for all the parameters, respectively. As shown in Refs. [7] and [9] assuming the components can not be repaired or replaced, the lower bound of the survival function can be computed as follows:

$$\underline{S}_{T_S}(t) = \underline{P}(T_S > t) = \sum_{l_1=0}^{m_1} \dots \sum_{l_K=0}^{m_K} \Phi(l_1, \dots, l_K) \prod_{k=1}^K \bar{D}(C_k(t) = l_k) \quad (5)$$

where $C_k(t)$ denotes the number of k components working at time t , and

$$\bar{D}(C_k(t) = l_k) = \bar{P}(C_k(t) \leq l_k) - \bar{P}(C_k(t) \leq l_k - 1). \quad (6)$$

While the corresponding upper bound of the survival function is:

$$\bar{S}_{T_S}(t) = \bar{P}(T_S > t) = \sum_{l_1=0}^{m_1} \dots \sum_{l_K=0}^{m_K} \Phi(l_1, \dots, l_K) \prod_{k=1}^K \underline{D}(C_k(t) = l_k) \quad (7)$$

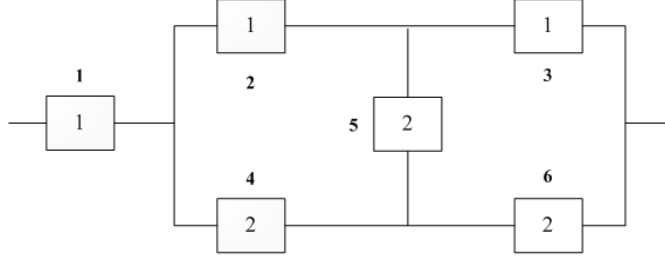

Figure 2: Bridge system with two types of components. The numbers inside the boxes indicate the component type. The numbers above the boxes indicate the component indices.

Table 1: Survival signature of the bridge system of Figure 2

l_1	l_2	$\Phi(l_1, l_2)$
0	[0, 1, 2, 3]	0
[1, 2]	[0, 1]	0
1	2	1/9
1	3	1/3
2	2	4/9
2	3	2/3
3	[0, 1, 2, 3]	1

where

$$\underline{D}(C_k(t) = l_k) = \underline{P}(C_k(t) \leq l_k) - \underline{P}(C_k(t) \leq l_k - 1). \quad (8)$$

4. Numerical Examples

4.1. Bridge system with not repairable components

The purpose of this numerical example is to verify the proposed algorithms since for this simple problem analytical solutions are available. The system configuration is represented in Figure 2, $k = 1, 2$. The bridge system comprises of 325 six components, which belonging to two types. It has no series section or parallel section which can enable simplification. The survival signature can easily be computed either manually or using the R-package *ReliabilityTheory* [19]. The values of the survival signature are reported in Table 1 where l_1 and l_2 indicate the number of working component of type $k = 1$ and $k = 2$, respectively and $\Phi(l_1, l_2)$ is the 330 survival signature of the bridge system. In this example the failure times of both component type 1 and 2 are obeying to exponential distributions with parameters $\lambda_1 = 0.8$ and $\lambda_2 = 1.5$, respectively, i.e. the components have a constant mean time to fail. It is also assumed that the component once failed can not be repaired.

The survival function of the bridge system is then calculated by means of the Algorithms 1 and 2. The resulting functions are then compared with the analytical

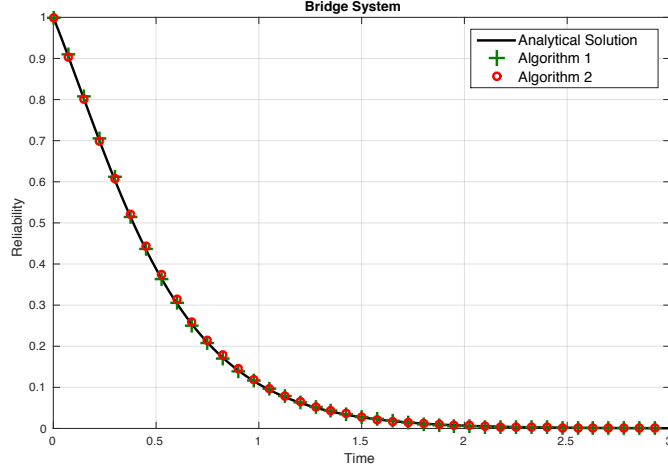

Figure 3: Survival function of the bridge system calculated by two simulation methods and analytical method, respectively.

solution. The survival function can be obtained from Equations (3) and (2):

$$P(T_S > t) = \sum_{l_1=0}^3 \sum_{l_2=0}^3 \Phi(l_1, l_2) \binom{3}{l_1} [1 - e^{-0.8t}]^{3-l_1} [e^{-0.8t}]^{l_1} \times \binom{3}{l_2} [1 - e^{-1.5t}]^{3-l_2} [e^{-1.5t}]^{l_2} \quad (9)$$

335 The results of the reliability analysis are shown in Figure 3, which shows a perfect agreement of the simulation methods with the analytical solution. The Monte Carlo simulation has been performed using $N = 5000$ samples and a discretisation time $dt = 0.0015$. The discretization time is only required to collect the numerical results (i.e. survival function) although the simulation of the system is continuous with respect to the time. Figure 4 shows an example of system evolution as a function of time with associate number of working component C_k . In order to show the efficiency of the proposed algorithm, the evolution of the variance of the estimators as a function of number of samples has been computed and shown in Figure 5. Algorithm 2 shows a smaller variance compared to Algorithm 1, in particular when small sample sizes are used.

345 The bridge system is also analysed in presence of imprecision on the parameters of the failure distribution time. In this case it is assumed that the parameters of the component failure time are not known precisely. The bounds of the parameter distributions are $\lambda_1 = [0.4, 1.2]$ and $\lambda_2 = [1.3, 2.1]$. The bounds of the survival functions are computed by means of the Algorithms 1 and 2. Since this system

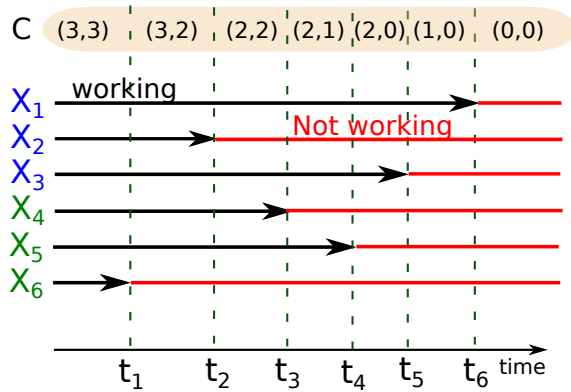

Figure 4: Realization of the number of working component C_k as a function of time.

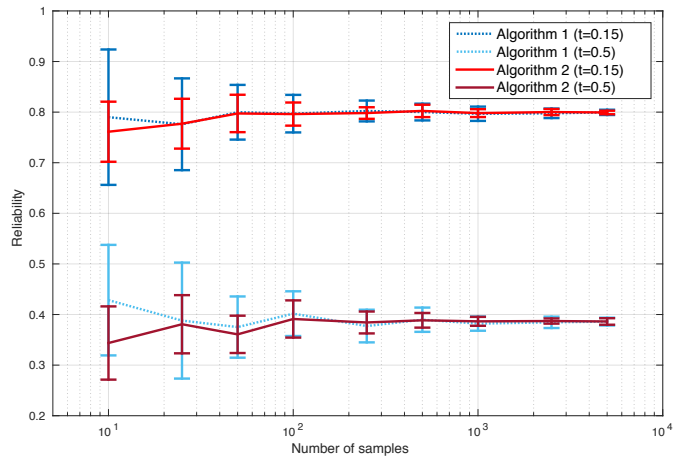

Figure 5: Variance of the estimator of the survival function.

is a coherent system, only two numerical simulations are required, i.e. the lower bound of the survival function is computed using the lower bounds of the parameter distribution and the upper bound is obtained adopting the upper bounds of the parameters λ_1 and λ_2 . The results are then compared to the analytical solution
355 adopting the method presented in [9]. The results of the simulation have been further verified by estimating the survival function adopting a double loop approach. The double loop sampling involves two layers of sampling: the outer loop, called the parameter loop, samples values from the set of distribution parameters; while the inner loop computes the survival function stating for the system knowing the precise probability distribution functions. Then, the lower and upper bounds of the survival function have been computed at each time of interest. The double
360 loop Monte Carlo analysis has been performed using $N = 5000$ samples for the

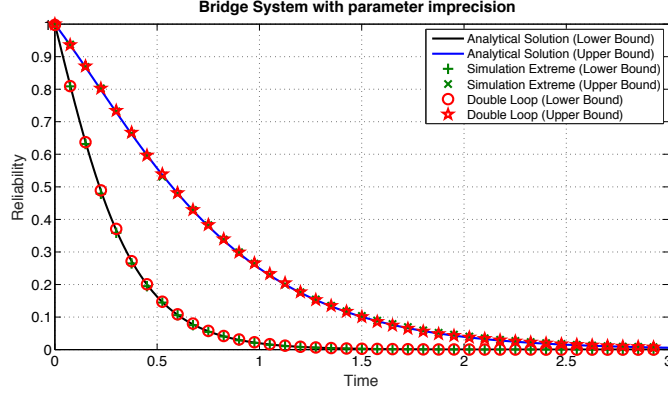

Figure 6: Bounds of the survival function of the bridge system calculated by means of the Algorithm 1 and 2 using bounds of the distribution parameter (Simulation Extreme) and compared with analytical solutions and the double loop approach.

inner loop and 1000 samples for the parameter loop. The results are collected in a counter using a discretisation time step $dt = 0.0015$.

365 The results of the simulation considering imprecision are reported in Figure 6 showing a perfect agreement with the analytical solutions.

4.2. Bridge system with repairable components

370 In this example the components of the bridge system shown in Figure 2 are considered repairable. Hence, the components can be in two different states: working ($s = 1$) and not-working ($s = 2$). Two cases are analysed considering different distributions for the repair times as shown in Table 2. Analytical solutions are

Table 2: Parameters of repairable components in the bridge system. State 1: Working, State 2: Not-working.

C. type (k)	Transition (s)	Distribution	Parameters
CASE A			
1	1 → 2	Exponential (λ)	(0.8)
1	2 → 1	Weibull (scale,shape)	(0.9, 1.2)
2	1 → 2	Exponential (λ)	(1.5)
2	2 → 1	Weibull (scale,shape)	(1.3, 1.8)
CASE B			
1	1 → 2	Exponential (λ)	(0.8)
1	2 → 1	Uniform (min,max)	(0.2, 0.6)
2	1 → 2	Exponential (λ)	(1.5)
2	2 → 1	Uniform (min,max)	(0.1, 0.2)

not available for analysing repairable systems and the system can only be analysed by adopting simulation methods such as the Algorithm 3. The estimated survival function $P(T_S > t)$ is shown in Figures 8 and 10 for the CASE A and B, respec-

375 tively. An example of the evolution of the system is represented in Figure 7. The survival function reach a stationary level that depends on the ratio between the mean failure time and mean repair time.

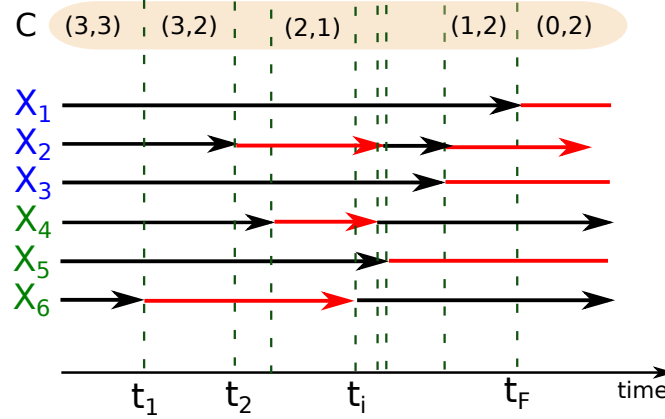

Figure 7: Realization of the number of working component C_k as a function of time.

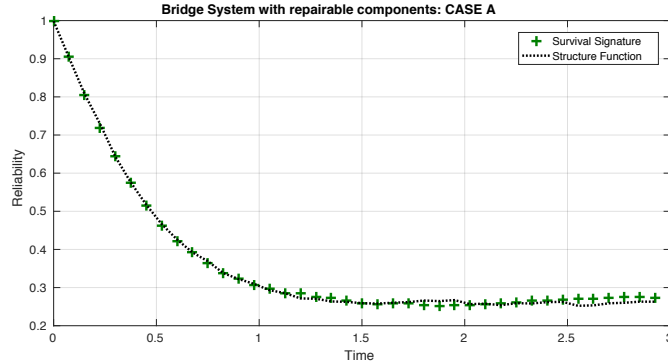

Figure 8: CASE A: Survival function of the bridge system with repairable components calculated by means of the Algorithm 3 and a simulation method based on structure function.

It is important to notice that the proposed approach (Algorithm 3) does not require the introduction of additional component types to analyse a system with repairable components. In order to verify the correctness of Algorithm 3 which is based on survival signature, the results have been compared with the solution of simulation method based on the structural function. The minimum path sets of the Bridge system shown in Figure 2 are $[1,2,3]$, $[1,2,5,6]$, $[1,3,4,5]$ and $[1,4,6]$. $N = 5000$ samples have been used to estimate the reliability of the system and the results shown in Figures 8 and 10 are in perfect agreement with the results obtained using Algorithm 3. Figures 9 and 11 compare the variance of the estimator as a

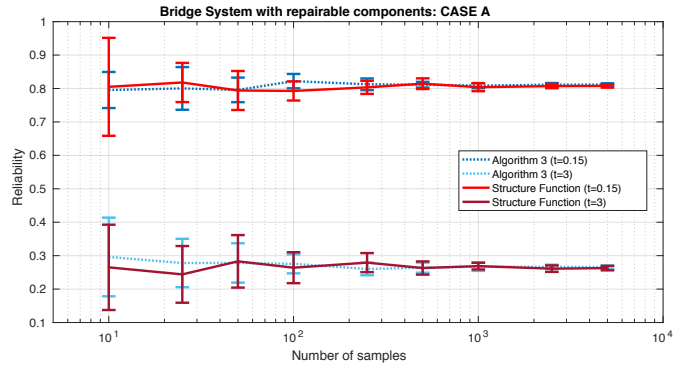

Figure 9: CASE A: Variance of the estimator for the bridge system with repairable components calculated by means of the Algorithm 3 and a simulation method based on structure function.

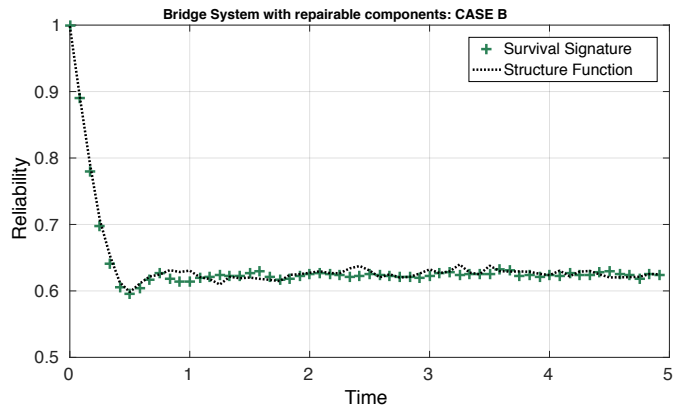

Figure 10: CASE B: Survival function of the bridge system with repairable components calculated by means of the Algorithm 3 and a simulation method based on structure function.

function of the number of samples adopting the Algorithm 3 based on survival signature and Monte Carlo method based on structural function.

4.3. Grey System

390 In order to illustrate the efficiency and the applicability of the proposed simulation approaches a complex system composed by 8 components of 5 types is analysed. The component failure types and distribution parameters are shown in Table 3, again affected by imprecision. In addition, it is assumed that the exact configuration of part of the system is unknown as shown in Figure 12, i.e. it might
 395 be composed by an additional component of type 1 or two components of type 2 connected in parallel. However, the system can still be described using the survival signature although affected by imprecision [6]. This has the advantages of more realistic reflections of uncertainty on system functioning and the proposed

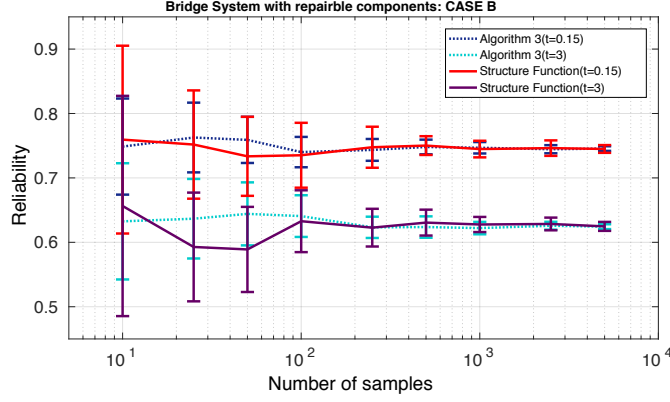

Figure 11: CASE B: Variance of the estimator with repairable components calculated by means of the Algorithm 3 and a simulation method based on structure function.

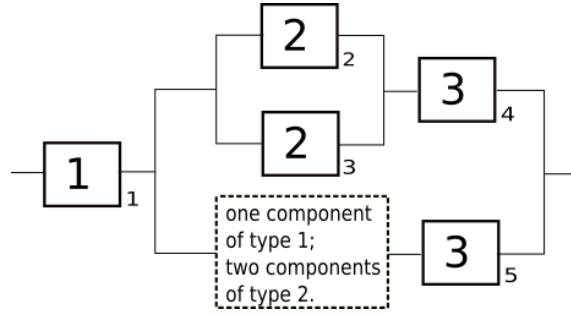

Figure 12: Grey system composed by eight components of 5 types with imprecision of the exact system configuration.

simulation methods are also directly applicable . Table B.7 shows the imprecise
 400 structural signature. For instance, if 2 components of type 1 and 1 component of
 type 3 are working the system can be either in a failing state or working with a
 probability of 0.5 (if the unknown part of the system is composed by an additional
 component of type 1). Since the system in Figure 12 is a coherent system, Al-
 gorithm 2 is used to estimated the bounds of the survival function by collecting
 405 the bound values (i.e. intervals) of the survival signature during the Monte Carlo
 simulation. In other words, the failure times of the components are sampled using
 the bounds of the failure time distribution as shown in the previous Section. In
 addition, in the Step 5' of Algorithm 2, the values of the survival signatures $\underline{\Phi}_{t_i}$
 and $\overline{\Phi}_{t_i}$ are evaluated and in the Step 6' their values collected in two counters
 410 $\underline{Vr}(t) = \underline{Vr}(t) + \underline{\Phi}_{t_i}$ and $\overline{Vr}(j) = \overline{Vr}(j) + \overline{\Phi}_{t_i}, \forall j : j \cdot dt < t_i$. Hence, no additional
 Monte Carlo simulation are required to estimate the bounds of the survival func-
 tion (the system reliability). If the component failure times are not affected by

Table 3: Components failure types and distribution parameters for system of Fig.12

Component type	Distribution	Parameters
1	Weibull (scale,shape)	$([1.6, 1.8], [3.3, 3.9])$
2	Exponential (λ)	$([2.1, 2.5])$
3	Weibull (scale,shape)	$([3.1, 3.3], [2.3, 2.7])$

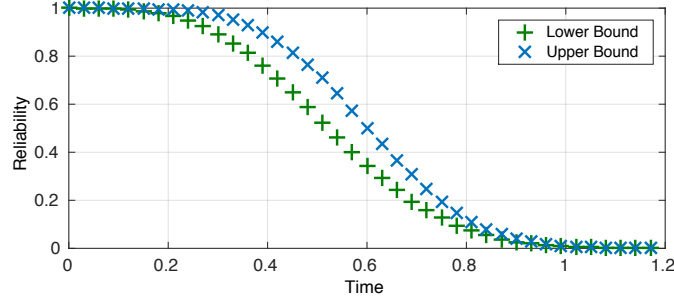

Figure 13: Upper and lower bounds of survival function for the system in Fig 12.

imprecision, only one Monte Carlo simulation would have been required to analyse the system with imprecision in the survival signature. In principle, Algorithm 1 can also be used for the estimation of the reliability bounds although it requires some modifications in the sampling of the system status.

The upper and lower bounds of survival function for the system with imprecision both in the survival signature and on the component distribution parameters are shown in Figure 13. The simulations have been performed using 5000 samples. This example shows the flexibility and the applicability of the simulation approaches proposed for the analysing of a systems affected by imprecision where no analytical solutions are available.

4.4. Complex System

In order to illustrate the efficiency and the applicability of the proposed simulation approaches, a complex system composed by 14 repairable components of 6 different types is analysed. The reliability block diagram of the system is shown in Figure 14 and the parameters of the components are reported in Table 4. The survival signature of this system can be referred in Appendix B.

First, the system is analysed without considering the repairs (i.e. transition $2 \rightarrow 1$ is not allowed). Hence, the reliability of the system can be estimated adopting the proposed Algorithms 1 and 2. The results are shown in Figure 15 and Figure 16 for the case of non-repairable components with precise parameters and with imprecise parameters, respectively.

In case of repairable components or component with more than 1 allowed tran-

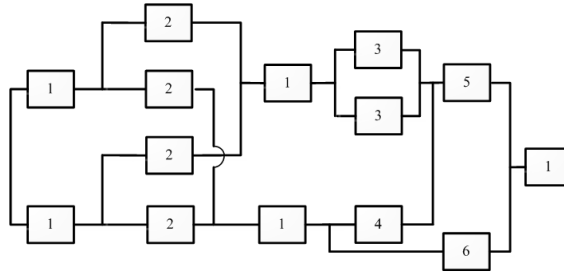

Figure 14: Reliability block diagram of the 16 component system.

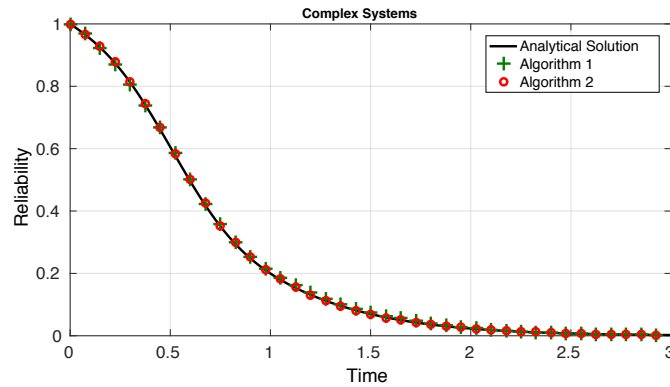

Figure 15: Survival function of the complex system calculated by Algorithms 1 and 2 and compared with analytical solution

435 sition, Algorithm 3 needs to be used. The proposed approach is generally applica-
 ble and allows to estimate the reliability of complex system based on the survival
 function. Figure 17 shows the survival function for the case of repairable compo-
 nents. The black line shows the results when the parameters of the failure and
 repair distributions are precisely known.

440 When imprecisions are considered within repairable system, the bounds of the
 survival function can be estimated by means of only two simulations as shown in
 Figure 6. These analyses require the calculation of the cumulative distribution
 function (CDF) bounds for component failure and repair, which are expressed as
 $[\underline{F}, \overline{F}]$ and $[\underline{R}, \overline{R}]$ respectively. Then, the lower bound of the survival function
 445 is estimated by considering the upper bound of the failure distributions and the
 lower bound for the repair distributions $(\overline{F}, \underline{R})$ while the upper bound is obtained
 adopting the lower bound for the failure distribution and the upper bound for the
 repair distribution $(\underline{F}, \overline{R})$. The interval of the survival function can be seen in
 Figure 17.

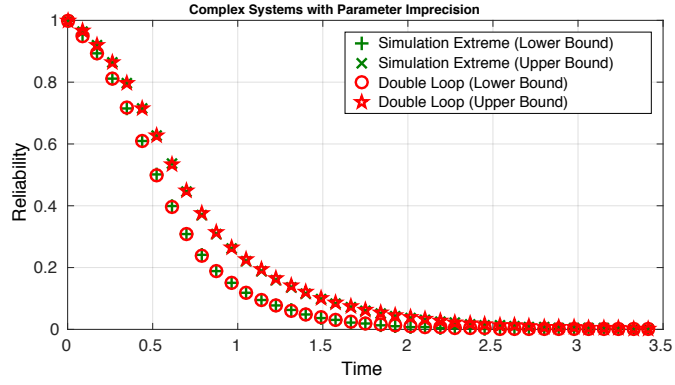

Figure 16: Bounds of survival function of the system with imprecision.

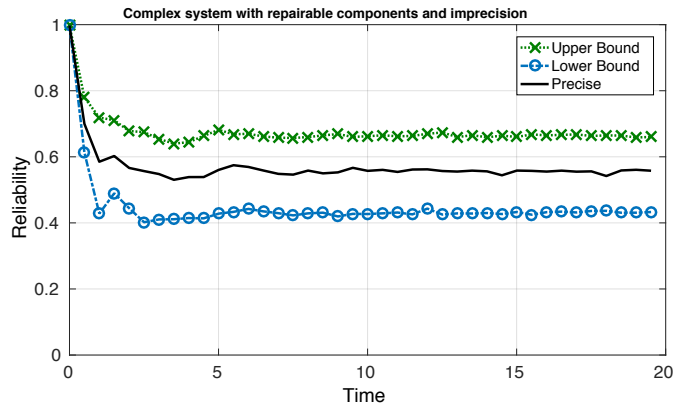

Figure 17: Survival function of the repairable complex system with imprecise and precise parameters, respectively.

Table 4: Components failure (transition $1 \rightarrow 2$) and repair (transition $2 \rightarrow 1$) data for each component type of the complex system.

Component type (k)	Transition (s)	Distribution	Precise parameters	Imprecise parameters
1	$1 \rightarrow 2$	Exponential (λ)	(2.3)	([2.1, 2.5])
1	$2 \rightarrow 1$	Uniform (min,max)	(0.4, 0.6)	([0.3, 0.5], [0.5, 0.7])
2	$1 \rightarrow 2$	Exponential (λ)	(1.2)	([0.9, 1.4])
2	$2 \rightarrow 1$	Uniform (min,max)	(0.9, 1.1)	([0.8, 1.0], [1.0, 1.2])
3	$1 \rightarrow 2$	Weibull (scale,shape)	(1.7, 3.6)	([1.6, 1.8], [3.3, 3.9])
3	$2 \rightarrow 1$	Uniform	(0.6, 0.8)	([0.5, 0.7], [0.7, 0.9])
4	$1 \rightarrow 2$	Lognormal (μ, σ)	(1.5, 2.6)	([1.3, 1.8], [2.3, 2.9])
4	$2 \rightarrow 1$	Uniform (min,max)	(1.0, 1.2)	([0.9, 1.1], [1.1, 1.3])
5	$1 \rightarrow 2$	Weibull (scale,shape)	(3.2, 2.5)	([3.1, 3.3], [2.3, 2.7])
5	$2 \rightarrow 1$	Uniform (min,max)	(1.2, 1.4)	([1.1, 1.3], [1.3, 1.5])
6	$1 \rightarrow 2$	Gamma (scale,shape)	(3.1, 1.5)	([2.9, 3.3], [1.3, 1.8])
6	$2 \rightarrow 1$	Uniform (min,max)	(1.1, 1.3)	([1.0, 1.2], [1.2, 1.4])

450 In terms of computational effort of the analysis, the calculation of the survival signature of the complex system using the R-package *ReliabilityTheory* requires only a few seconds on a common desktop computer.

455 The performance for very large numbers of components is an important topic for future research where it is important to separate computation of survival signature from the simulation of the system. The first part can already be done for quite substantial systems using the approach proposed in [10, 34] but which remains also a topic for research. The simulation of the system given the survival signature is almost independent on the number of components. In fact, the only parts of the simulation approach that scale with the number of components are 460 the Steps 1 and 2 of the algorithm. In these steps the failure time of components is sampled and then sorted. However, the computational cost of this part is negligible (fraction of seconds) up to million of components as shown in Figure 18. The figure shows the computational cost of sampling the failure time of components

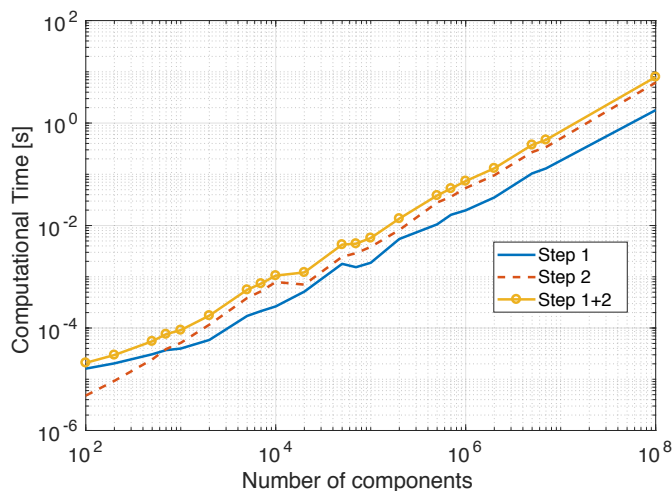

Figure 18: Scalability of the simulation algorithm with respect to the number of components (Steps 1 and 2 only).

465 from exponential distribution (Step 1 of the Algorithm) and then sorting all the
sampled times (Step 2). Steps 3-7 depend on the reliability of the components
and the time of interest (T_f) and scale linearly with the number of failures occurring
before the time of interest. Clearly the total simulation time depends on
the number of samples used. For the examples presented, the proposed simulation
470 methods allow to estimate the survival function in less than 20 seconds using 5000
samples on a common desktop.

5. Conclusions

The survival signature has been shown to be a practical method for performing
reliability analysis of complex systems with multiple component types. However,
analytical methods are applicable only in few cases or adopting different levels of
475 simplifications and assumptions.

In this paper, efficient simulation methods have been proposed for system reliability
analysis. The methods proposed are based on survival signature, which need
to be computed only once making the analysis very efficient. The proposed simulation
methods are generally applicable and they can be used to analyse realistic and
480 complex systems with non-repairable and repairable components. Recently, a case
has been made for allowing the structure function for system reliability to be a,
possibly imprecise, probability instead of a deterministic binary function [6]. This
has advantages of more realistic reflections of uncertainty on system functioning
and opens many interesting research questions. Such more general probabilistic
485 structure functions can also be used in the survival signature in a straightforward

manner, hence the simulation methods presented in this paper can also directly be applied.

The feasibility and effectiveness of the presented approaches have been illustrated with two numerical examples, the results indicate that simulation methods
490 based on survival signature are efficient for analysing reliability on complex systems.

Acknowledgement

This work was partially supported by the UK Engineering and Physical Sciences Research Council (EPSRC) grant EP/M018709/1.

495 Geng Feng would like to thank the support of China Scholarship Council.

Appendix A. Algorithms

The Algorithms 1-3 of the proposed methods are shown in this appendix. In the Algorithms the letter V is used to represent vectors while the letter M represents matrices. The symbol \sim is used represents sampling from given distribution.

500 Appendix B. Survival Signature

The tables in this appendix show the survival signature of the complex system of Figure 14. The rows with survival signature values equal to either 1 or 0 have been omitted.

Algorithm 1

Require: N : Num. of simulations; dt : Discretisation time; F_k : CDF failure times, $Vc = [m_1, m_2, \dots, m_k]$: Number of components per type; Nt number of discretisation steps,

Set $Vr(1:Nt)=0$ ▷ Initialise counter

Set $C=\text{sum}(Vc)$ ▷ Compute total number of components

Set $\Phi = \text{Survival signature}$ ▷ Compute the survival signature

for $n = 1 : N$ **do** ▷ loop over number of samples

for $k = 1 : K$ **do** ▷ loop over number of component type

for $j = 1 : m_k$ **do** ▷ loop over number of components

$Mf(j, k) \sim F_k$ ▷ Sample failure time component j of type k

end for

end for

$[Vt, Vi] = \text{sort}(Mf)$ ▷ Reorder transition times (Vt)

$\Phi_{Old} = 1$ ▷ Return component index vector (Vi)

for $m = 1 : C$ **do** ▷ Initialize variables

$Vc(Vi(m)) = Vc(Vi(m)) - 1$ ▷ Update number working components

$\Phi_{Now} = \Phi(Vc)$

$q \leftarrow \Phi_{Now} / \Phi_{Old}$

if $\text{rand}(1) < q$ **then** ▷ system working

$\Phi_{Old} = \Phi_{New}$

else

for all $j : j \cdot dt < Vi(m)$ **do**

$Vr(m) = Vr(m) + 1$ ▷ Update counter

end for

 Break ▷ Process next sample

end if

end for

$Vr = Vr / N$ ▷ Normalise counter

end for

Algorithm 2

Require: N : Num. of simulations; dt : Discretisation time; F_k : CDF failure times, $Vc = [m_1, m_2, \dots, m_k]$: Number of components per type; Nt number of discretisation steps,

Set $Vr(1:Nt)=0$ ▷ Initialise counter

Set $C=\text{sum}(Vc)$ ▷ Compute total number of components

Set $\Phi = \text{Survival signature}$ ▷ Compute the survival signature

for $n = 1 : N$ **do** ▷ loop over number of samples

for $k = 1 : K$ **do** ▷ loop over number of component type

for $j = 1 : m_k$ **do** ▷ loop over number of components

$Mf(j, k) \sim F_k$ ▷ Sample failure time component j of type k

end for

end for

$[Vt, Vi] = \text{sort}(Mf)$ ▷ Reorder transition times (Vt)

▷ Return component index vector (Vi)

$z = 1$ ▷ Initialize index

for $m = 1 : C$ **do** ▷ loop over number of components

$Vc(Vi(m)) = Vc(Vi(m)) - 1$ ▷ Update number working components

while $z \cdot dt \leq Vt(m)$ **do**

$Vr(z) = Vr(z) + \Phi(Vc)$ ▷ Update counter

$z = z + 1$ ▷ Update index

end while

end for

$Vr = Vr/N$ ▷ Normalise counter

end for

Algorithm 3

Require: N : Num. of simulations; dt : Discretisation time; F_k : CDF failure times, $Vc = [m_1, m_2, \dots, m_k]$: Number of components per type; Nt number of discretisation steps,

Set $Vr(1:Nt)=0$ ▷ Initialise counter

Set $C=\text{sum}(Vc)$ ▷ Compute total number of components

Set $\Phi = \text{Survival signature}$ ▷ Compute the survival signature

Set $Vs = \text{Initial component Status}$ ▷ System initial conditions

for $n = 1 : N$ **do** ▷ loop over number of samples

for $i = 1 : C$ **do** ▷ loop over number of components

$Vt(i) \sim F_{kl}$ ▷ Sample transition time component z of type k in state l

end for

$u = 1$ ▷ Initialise counter

while $\min(Vt) \leq Nt * dt$ **do**

$[tz, z] = \min(Vt)$ ▷ Identify first system transition tz

▷ and corresponding component index z

 Identify component type k of the component z

while $u \cdot dt \leq Vj$ **do**

$Vr(u) = Vr(u) + \Phi(Vk)$ ▷ Update counter

$u \leftarrow u + 1$ ▷ Update index

end while

if $Vs(z)$ is working **then**

$Vc(k) = Vc(k) - 1$ ▷ Update component counter

 Set $Vs(z)$ NOT working ▷ Update component status

else

$Vc(k) = Vc(k) + 1$ ▷ Update component counter

 Set $Vs(z)$ working ▷ Update component status

end if

 Set $Vt(z) \sim F_{kl}$ ▷ Sample new transition time component z

▷ of type k in the state $l = Vj(z)$

end while

end for

$Vr = Vr/N$ ▷ Normalise counter

Table B.5: Survival signature of a complex system in Figure 14; rows with $\Phi(l_1, l_2, l_3, l_4, l_5, l_6) = 0$ and $\Phi(l_1, l_2, l_3, l_4, l_5, l_6) = 1$ are omitted

l_1	l_2	l_3	l_4	l_5	l_6	$\Phi(l_1, l_2, l_3, l_4, l_5, l_6)$
3	1	0	[0,1]	[0,1]	1	1/20
3	1	0	1	1	0	1/20
3	1	1	0	[0,1]	1	1/20
3	1	1	1	0	1	1/20
3	1	2	[0,1]	0	1	1/20
3	1	2	0	1	0	1/20
3	1	1	[0,1]	1	1	1/10
3	1	1	1	1	0	1/10
3	1	2	0	1	1	1/10
3	1	2	1	1	[0,1]	1/10
3	2	0	0	[0,1]	1	1/10
3	2	0	1	0	1	1/10
3	2	0	1	1	[0,1]	1/10
3	2	1	[0,1]	0	1	1/10
3	2	1	0	1	0	1/10
3	2	2	[0,1]	0	1	1/10
3	2	2	0	1	0	1/10
3	3	0	[0,1]	[0,1]	1	3/20
3	3	0	1	1	0	3/20
3	3	[1,2]	[0,1]	0	1	3/20
3	3	1	0	1	0	3/20
3	3	2	0	1	0	3/20
3	4	0	[0,1]	[0,1]	1	1/5
3	4	0	1	1	0	1/5
3	4	[1,2]	[0,1]	0	1	1/5
3	4	1	0	1	0	1/5
3	4	2	0	1	0	1/5
4	1	0	[0,1]	[0,1]	1	1/5

Table B.6: Survival signature of a complex system in Figure 14; rows with $\Phi(l_1, l_2, l_3, l_4, l_5, l_6) = 0$ and $\Phi(l_1, l_2, l_3, l_4, l_5, l_6) = 1$ are omitted

l_1	l_2	l_3	l_4	l_5	l_6	$\Phi(l_1, l_2, l_3, l_4, l_5, l_6)$
4	1	0	1	1	0	1/5
4	1	[1,2]	[0,1]	0	1	1/5
4	1	1	0	1	0	1/5
4	1	2	0	1	0	1/5
3	2	[1,2]	[0,1]	1	1	4/15
3	2	1	1	1	0	4/15
3	2	2	1	1	0	4/15
4	2	[0,1,2]	[0,1]	0	1	11/30
4	2	0	0	1	1	11/30
4	2	0	1	1	[0,1]	11/30
4	2	1	0	1	0	11/30
4	2	2	0	1	0	11/30
3	[3,4]	1	[0,1]	1	1	2/5
3	3	1	1	1	0	2/5
3	3	2	0	1	1	2/5
3	3	2	1	1	[0,1]	2/5
3	4	1	1	1	0	2/5
3	4	2	[0,1]	1	1	2/5
3	4	2	1	1	0	2/5
4	1	[1,2]	[0,1]	1	1	2/5
4	1	[1,2]	1	1	0	2/5
4	3	0	[0,1]	[0,1]	1	1/2
4	3	0	1	1	0	1/2
4	3	[1,2]	[0,1]	0	1	1/2
4	3	1	0	1	0	1/2
4	3	2	0	1	0	1/2
5	1	0	[0,1]	[0,1]	1	1/2
5	1	0	1	1	0	1/2

Table B.7: Imprecise survival signature of the system of Fig.12, $\phi(l_1, l_2, l_3) = 0$ and $\phi(l_1, l_2, l_3) = 1$ for both lower and upper bounds are omitted.

l_1	l_2	l_3	$[\phi(l_1, l_2, l_3)]$
1	1	1	$[1/8, 1/8]$
1	1	2	$[1/4, 1/4]$
1	2	1	$[1/5, 1/4]$
1	2	2	$[3/7, 1/2]$
1	3	1	$[1/4, 3/8]$
1	3	2	$[1/2, 1/2]$
1	4	1	$[1/4, 1/2]$
1	4	2	$[1/2, 1/2]$
2	0	1	$[0, 1/2]$
2	0	2	$[0, 1]$
2	1	1	$[1/4, 3/4]$
2	1	2	$[1/2, 1]$
2	2	1	$[1/2, 1]$
2	3	1	$[3/4, 1]$

Table B.8: Survival signature of a complex system in Figure 14; rows with $\Phi(l_1, l_2, l_3, l_4, l_5, l_6) = 0$ and $\Phi(l_1, l_2, l_3, l_4, l_5, l_6) = 1$ are omitted

l_1	l_2	l_3	l_4	l_5	l_6	$\Phi(l_1, l_2, l_3, l_4, l_5, l_6)$
5	1	$[1, 2]$	$[0, 1]$	0	1	$1/2$
5	1	1	0	1	0	$1/2$
5	1	2	0	1	0	$1/2$
4	4	0	$[0, 1]$	$[0, 1]$	1	$3/5$
4	4	0	1	1	0	$3/5$
4	4	$[1, 2]$	$[0, 1]$	0	1	$3/5$
4	4	1	0	1	0	$3/5$
4	4	2	0	1	0	$3/5$
4	2	$[1, 2]$	$[0, 1]$	1	1	$2/3$
4	2	1	1	1	0	$2/3$
4	2	2	1	1	0	$2/3$
4	3	$[1, 2]$	$[0, 1]$	1	1	$4/5$
4	3	1	1	1	0	$4/5$
4	3	2	1	1	0	$4/5$
4	4	$[1, 2]$	$[0, 1]$	1	1	$4/5$
4	4	1	1	1	0	$4/5$
4	4	2	1	1	0	$4/5$
5	2	0	$[0, 1]$	$[0, 1]$	1	$5/6$
5	2	0	1	1	0	$5/6$
5	2	$[1, 2]$	$[0, 1]$	0	1	$5/6$
5	2	$[1, 2]$	0	1	0	$5/6$

References

- [1] K. Kołowrocki, B. Kwiatkowska-Sarnecka, Reliability and risk analysis of large systems with ageing components, *Reliability Engineering & System Safety* 93 (12) (2008) 1821–1829.
- [2] M. Modarres, What every engineer should know about reliability and risk analysis, Vol. 30, CRC Press, 1992.
- [3] F. J. Samaniego, System signatures and their applications in engineering reliability, Vol. 110, Springer Science & Business Media, 2007.
- [4] S. Eryilmaz, Review of recent advances in reliability of consecutive k-out-of-n and related systems, *Proceedings of the Institution of Mechanical Engineers, Part O: Journal of Risk and Reliability* 224 (3) (2010) 225–237.
- [5] F. P.A. Coolen, T. Coolen-Maturi, Generalizing the signature to systems with multiple types of components, in: *Complex Systems and Dependability*, Springer, 2012, pp. 115–130.
- [6] F. P. Coolen, T. Coolen-Maturi, The structure function for system reliability as predictive (imprecise) probability., *Reliability Engineering and System Safety* (154) (2016) 180–187.
- [7] F. P.A. Coolen, T. Coolen-Maturi, A. H. Al-Nefaiee, Nonparametric predictive inference for system reliability using the survival signature, *Proceedings of the Institution of Mechanical Engineers, Part O: Journal of Risk and Reliability* 228 (5) (2014) 437–448.
- [8] L. J.M. Aslett, F. P.A. Coolen, S. P. Wilson, Bayesian inference for reliability of systems and networks using the survival signature, *Risk Analysis* 35 (3) (2015) 1640–1651.
- [9] G. Feng, E. Patelli, M. Beer, F. P. Coolen, Imprecise system reliability and component importance based on survival signature, *Reliability Engineering & System Safety* 150 (2016) 116–125.
- [10] S. Reed, An efficient algorithm for exact computation of system and survival signatures using binary decision diagrams, *Reliability Engineering & System Safety* 165 (2017) 257–267. doi:10.1016/j.ress.2017.03.036. URL <http://dx.doi.org/10.1016/j.ress.2017.03.036>
- [11] P. R. Adduri, R. C. Penmetsa, System reliability analysis for mixed uncertain variables, *Structural Safety* 31 (5) (2009) 375–382.
- [12] T. Augustin, F. P.A. Coolen, G. de Cooman, M. C.M. Troffaes, *Introduction to imprecise probabilities*, John Wiley & Sons, 2014.
- [13] J. Butler, J. Jia, J. Dyer, Simulation techniques for the sensitivity analysis of multi-criteria decision models, *European Journal of Operational Research* 103 (3) (1997) 531–546.
- [14] R. Y. Rubinstein, Optimization of computer simulation models with rare events, *European Journal of Operational Research* 99 (1) (1997) 89–112.
- [15] S. H. Zanakis, A. Solomon, N. Wishart, S. Dubish, Multi-attribute decision making: A simulation comparison of select methods, *European journal of operational research* 107 (3) (1998) 507–529.
- [16] E. Zio, P. Baraldi, E. Patelli, Assessment of the availability of an offshore installation by monte carlo simulation, *International Journal of Pressure Vessels and Piping* 83 (4) (2006) 312–320.

- [17] H. George-Williams, E. Patelli, A hybrid load flow and event driven simulation approach to multi-state system reliability evaluation, *Reliability Engineering & System Safety* 152 (2016) 351367. doi:10.1016/j.ress.2016.04.002.
- [18] J. Song, W.-H. Kang, System reliability and sensitivity under statistical dependence by matrix-based system reliability method, *Structural Safety* 31 (2) (2009) 148 – 156, risk Acceptance and Risk Communication, Risk Acceptance and Risk Communication. doi:DOI:10.1016/j.strusafe.2008.06.012.
URL <http://www.sciencedirect.com/science/article/B6V54-4T6KF7K-2/2/a3c60ec860317e6a429b905d0f00f69c>
- [19] L. J.M. Aslett, Reliabilitytheory: Tools for structural reliability analysis. r package (2012).
URL www.louisaslett.com
- [20] L. J.M. Aslett, MCMC for inference on phase-type and masked system lifetime models, Ph.D. thesis, Trinity College Dublin (2012).
- [21] E. Patelli, Handbook of Uncertainty Quantification, Springer International Publishing, Cham, 2016, Ch. COSSAN: A Multidisciplinary Software Suite for Uncertainty Quantification and Risk Management, pp. 1–69. doi:10.1007/978-3-319-11259-6_59-1.
URL http://dx.doi.org/10.1007/978-3-319-11259-6_59-1
- [22] E. Patelli, M. Broggi, M. de Angelis, M. Beer, OpenCossan: An efficient open tool for dealing with epistemic and aleatory uncertainties, in: *Vulnerability, Uncertainty, and Risk Quantification, Mitigation, and Management*, ASCE, 2014, pp. 2564–2573.
- [23] M. Marseguerra, E. Zio, Basics of the Monte Carlo Method with Application to System Reliability, LiLoLe Publishing, Hagen/Germany, 2002, iSBN: 3-934447-06-6.
- [24] D. A. Alvarez, Infinite random sets and applications in uncertainty analysis, Ph.D. thesis, Arbeitsbereich für Technische Mathematik am Institut für Grundlagen der Bauingenieurwissenschaften. Leopold-Franzens-Universität Innsbruck, Innsbruck, Austria, available at <https://sites.google.com/site/diegoandresalvarezmarin/RStthesis.pdf> (2007).
- [25] B. Möller, M. Beer, Fuzzy-randomness - uncertainty in civil engineering and computational mechanics, Springer-Verlag, 2004.
- [26] M. Beer, S. Ferson, Imprecise probabilities-what can they add to engineering analyses?, *Mechanical Systems and Signal Processing* 37 (1-2) (2013) 1 – 3.
- [27] S. Ferson, V. Kreinovich, L. Ginzburg, D. S. Myers, K. Sentz, Constructing probability boxes and Dempster-Shafer structures, Report SAND2002-4015, Sandia National Laboratories, Albuquerque, NM, available at <http://www.ramas.com/unabridged.zip> (January 2003).
- [28] M. Beer, Y. Zhang, S. T. Quek, K. K. Phoon, Reliability analysis with scarce information: Comparing alternative approaches in a geotechnical engineering context, *Structural Safety* 41 (0) (2013) 1 – 10. doi:<http://dx.doi.org/10.1016/j.strusafe.2012.10.003>.
URL <http://www.sciencedirect.com/science/article/pii/S0167473012000689>
- [29] R. E. Moore, R. B. Kearfott, M. J. Cloud, Introduction to Interval Analy-

- 595 sis, Society for Industrial and Applied Mathematics, Philadelphia, PA, USA,
2009.
- [30] E. Patelli, D. A. Alvarez, M. Broggi, M. de Angelis, Uncertainty management
in multidisciplinary design of critical safety systems, *Journal of Aerospace
Information Systems* 12 (2015) 140–169. doi:10.2514/1.I010273.
- 600 [31] M. Beer, S. Ferson, V. Kreinovich, Imprecise probabilities in engineering anal-
yses, *Mechanical systems and signal processing* 37 (1) (2013) 4–29.
- [32] L. V. Utkin, F. P. Coolen, Imprecise reliability: an introductory overview,
in: *Computational intelligence in reliability engineering*, Springer, 2007, pp.
261–306.
- 605 [33] S. Ferson, C. A. Joslyn, J. C. Helton, W. L. Oberkampf, K. Sentz, Summary
from the epistemic uncertainty workshop: consensus amid diversity, *Reliabil-
ity Engineering & System Safety* 85 (1) (2004) 355–369.
- [34] G. Feng, S. Reed, E. Patelli, M. Beer, F. P. Coolen, Efficient reliability and
uncertainty assessment on lifeline networks and imprecise survival signature,
610 in: *2nd ECCOMAS Thematic Conference on Uncertainty Quantification in
Computational Sciences and Engineering*, 2017.