

Background Analysis for Local Power, Local Benefit Project

Report produced by University of Strathclyde

Authors:

Milana Plecas: milana.plecas@strath.ac.uk

Simon Gill: simon.gill@strath.ac.uk

Ivana Kockar: ivana.kockar@strath.ac.uk

Date of Issue: 12th February 2015

Status: Final

This report is supported by Scottish Power Energy Networks through Accelerating Renewable Connections (ARC) project.

CONTENTS

1	Introduction.....	4
2	Background Analysis.....	7
2.1	Wind Farm Curtailment Analysis	7
2.1.1	Input data.....	8
2.1.2	Methodology, Analysis and Results	10
2.2	Solar Generation Analysis.....	13
2.2.1	Input data.....	15
2.2.2	Methodology and Analysis.....	17
2.2.3	Results.....	20
3	Summary and Conclusions	22
	APPENDIX 1: The Simplified LPLB Model.....	23
	APPENDIX 2: Summary of Background Analysis Flowcharts	24
	A2.1 – Wind Farm Curtailment Analysis.....	24
	A2.2 – Solar Generation Analysis	25

1 INTRODUCTION

The objective of this report is to provide details of background analysis into the potential impact of *Local Power, Local Benefit* (LPLB) project on the local distribution network. The work has been carried out by the University of Strathclyde (UoS) to support LPLB. The project is led by Community Energy Scotland (CES) and was successful in the Local Energy Challenge Fund (LECF) phase 1¹. The LPLB project falls within an area of electrical distribution network that is focus of Scottish Power Energy Network's (SPEN) Low Carbon Network Fund (LCNF) funded Accelerating Renewables Connections (ARC) project. This background analysis supports development work towards the LECF phase 2 application.

The *Local Power, Local Benefit* project aims to develop a scheme that will install and operate additional renewable generation and controllable flexible electricity demand, such as heat pumps or hot water tanks, in order to maximise renewable generation connections and reduce fuel poverty in East Lothian and the Scottish Borders. The LPLB project will carry out a field trial to evaluate benefits of using flexible electrical demand for a Demand Side Response (DSR) scheme which will help relieve network constraints and create a synergy with the ARC project by developing up to 1MW of controllable demand. In that way, LPLB will integrate with the evolving Active Network Management (ANM) scheme in order to absorb the output of local community generation when the network in this region is constrained. This typically happens at times of high generation output and lower demand.

The ARC project² is an investigation of the options for using local demand to accelerate the connection of renewable DG capacity, with specific reference to community renewables within the ARC region.

In Figure 1 ARC trial area is indicated in green, and the LPLB project area is within a black circuted area.



Figure 1: The ARC trial area and location of the LPLB project

The area proposed for the LPLB project has substantial existing renewable generation and significant potential for further growth, as well as an acute need for affordable heating. However, the connection of

¹ <http://www.localenergyscotland.org/funding-resources/funding/local-energy-challenge-fund/phase-one-projects/local-power,-local-benefit-managing-demand-in-berwickshire-as-a-means-to-maximise-renewables-generation-and-minimise-fuel-poverty/>

² ARC website: www.arc-project.com

further community, small and medium scale renewable generation is limited by the capacity of the distribution network to cope with further distributed generation. For example, one of the Grid Supply Points (GSP) is export constrained, and some parts of the local grid are highly constrained by voltage rise issues. This means that renewable generation developers without solutions which involve new methods of managing the network and its customers – both generators and demand – may face long delays to progress their projects. The main goal of the LPLB project is to enable integration of new DG connections via coordinated demand side response to reduce curtailment of local generation. The project will develop commercial and technical solutions for the installation of nearly 750 roof-mounted on-site photovoltaic (PV) panels for Berwickshire Housing Association (BHA) social housing tenants and community facilities. In addition to the solar panels BHA's 9MW consented Hoprigshiels wind farm is under development and LPLB will facilitate the integration of another nearby off-site Ferneylea wind farm through a non-firm connection agreement and demand side response. This means that the controllable electricity demand resources proposed under LPLB, i.e. heat batteries and heat pumps, will allow the connection of additional renewable generation that would otherwise be rejected by the Distributed Network Operator (DNO).

There are significant challenges facing community energy schemes that aim to couple local flexible demand with local generation. Approaches to address these issues have been reviewed in a report produced by the University of Strathclyde for the ARC project³. The challenges identified include the arrangement of network operation and communications, electrical connection and commercial arrangements, as well as regulatory and principle of access issues. For the LPLB project, connection arrangements, as well as commercial and regulatory structures, required to support them are of particular interest.

Although the proposed geographical area has significant potential for renewable generation, the local electricity network is constrained on both transmission and distribution levels. The constrained GSP at Dunbar requires curtailment of generation on the distribution network to stay within its thermal limits. The LPLB project will also help the DNO manage 11kV voltage limits as well as thermal and voltage limits on the Low Voltage (LV) network for the new generation.

The LPLB project involves a number of stakeholders including consumers, suppliers, generators, DNOs. As outlined in the application for LECF phase 1, LPLB stakeholders are:

- **Community Energy Scotland (CES)** is a Scottish national charity which supports communities to develop renewable energy projects. These includes projects that maximise the use of local energy and overcome grid constraints through direct supply, demand side management, intelligent heating system, electric vehicle loads, energy storage, and novel business models that allow more active management of local resources.
- **Berwickshire Housing Association (BHA)** is the owner of the properties proposed for PV installations (this indirectly includes BHA tenants as consumers). BHA provides accommodation to some of the most disadvantaged and vulnerable households in Berwickshire and there will be significant benefits for tenants since the PV panels and new heating system will reduce their heating bills. BHA also has a 9MW consented Hoprigshiels wind farm under development whose output will be constrained by local grid issues.
- **Ferneylea 1 Ltd** is a private limited company established to develop and manage a small wind farm adjacent to the BHA wind farm site. As a local renewable generator, whose output will potentially be subjected to constraints, the company is interested in directly participating in the LPLB project to reduce its curtailment.

³ Gill, S., Plecas, M., Kockar, I., 'Coupling Demand and Distributed Generation to Accelerate Renewable Connections: Options for the Accelerating Renewable Connections project', 2014. Available at: <http://strathprints.strath.ac.uk/50135/>

- **Sunamp** is a company that develops thermal heating storage. Their devices will be used in the LPLB project as a controllable demand. The company has already demonstrated the performance, reliability and robustness of the technology in the BHA six house trials⁴. By integrating this advanced storage technology with domestic heat pumps, highly efficient and highly effective heating and hot water systems is provided.
- **Our Power (Energy) Ltd** is a social enterprise energy supply company. Our Power will work with community-base and other generators to provide cheap, green electricity and heat. They will facilitate reduction of renewable generation curtailments through aggregation of demand with switchable load.
- **Edison Energy**, a company which owns PV panels and will do all the installation on BHA properties' roofs.
- **Scottish Power Energy Networks (SPEN)** is the local DNO, who will support this project through the ARC project.

In order to support the LECF phase 2 application of the LPLB project, the UoS has carried out background analysis to evaluate the likely baseline level of curtailment to be expected at the Ferneylea wind farm, when there is no demand side response available, and to estimate a generation envelope for the new PV portfolio in order to provide the DNO with information on what may happen. Detailed explanation of the modelling work and associated results are described in Section 2.

⁴ The LPLB project application form for the Local Energy Challenge Fund phase 1.

2 BACKGROUND ANALYSIS

The LPLB project will provide switchable demand within BHA houses and will facilitate greater levels of local renewables generation. The background analysis carried out to support the LPLB project application for phase 2 of the LECF consists of two parts.

The first part (subsection 2.1) presents a wind analysis which identifies the likely baseline level of curtailment to be expected at the Ferneylea wind farm, but neglecting an influence of possible PV installations. The baseline represents the case where no demand side response is available, and gives an upper bound on the additional generation that can be facilitated by the flexible heating systems.

The second part (subsection 2.2) estimates a generation envelope for the new PV portfolio in order to provide the DNO with information on what may happen.

Analysis and results presented in this section are based on data provided by Smarter Grid Solutions (SGS), the developer of the ANM systems, CES and Edison Energy. A simplified schematic diagram indicating connections of renewable generation onto Dunbar GSP are given in Appendix 1. Dunbar GSP is used in this analysis due to its thermal constraints and limitation of export to transmission grid.

2.1 WIND FARM CURTAILMENT ANALYSIS

The proposed Ferneylea wind farm will be electrically connected to Dunbar GSP, and its location is indicated in Figure 2. This section presents analysis of curtailment of Ferneylea due to thermal constraints of the network.

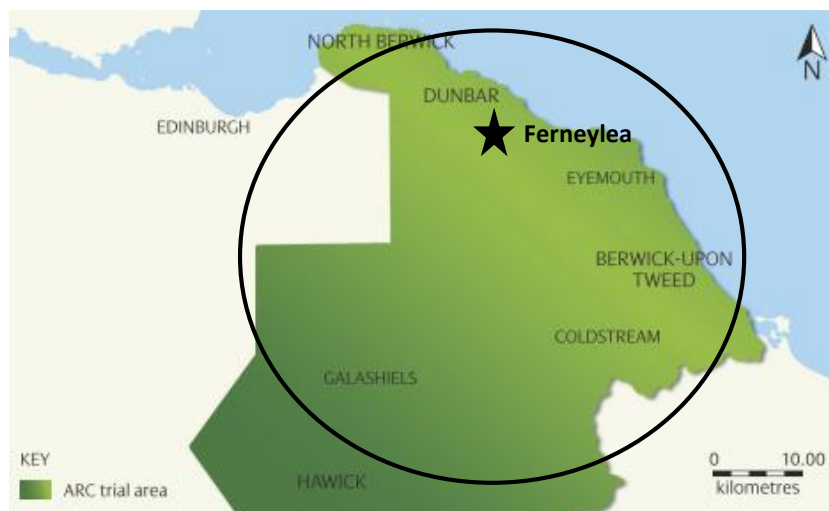

Figure 2: The ARC trial area with location of off-site wind farm

2.1.1 Input data

To calculate the expected curtailment at Ferneylea during each half hour of the 12 months period for the year 2011, two main sources of data were used: Smarter Grid Solutions (SGS) and Community Energy Scotland (CES).

SGS provided historical and estimated output data for DGs and demand connected to the Dunbar GSP, as well as assumptions about the operation of the ANM scheme (i.e. Last In First Off (LIFO) order). All of these were based on SPEN data, and include:

- Connection points for five wind farms (WF) as well as an incinerator – energy from waste (EFW) together with connection levels and their capacities, shown in Table 1.

• *Table 1: ANM scheme under Dunbar GSP*

Connected Generation	LIFO Priority	Connection level	Capacity (MW)
Crystal Rig WF	Firm	33kV	62
Aikengall WF	1	33kV	48
Viridor EFW	2	33kV	31 + 5
Hoprigshiels WF	3	33kV	9
Ferneylea WF	4	11kV	1.5
Kinegar WF	5	11kV	5

- The ANM stack positions of all of the above DGs, as well as for Ferneylea. The ‘stack’ list the priority with which each generation gains access to the distribution network during periods of constraint and is based on Last In First Off (LIFO).
- Levels of uncurtailed generation outputs for all other DGs⁵. As shown in Table 2, Crystal Rig and Aikengall wind farm outputs are based on historical time series of one year half-hourly data for 2011, while generation for Hoprigshiels and Kinegar wind farms were estimated by scaling Aikengall output to the capacity of each wind farm.

Table 2: Wind farm characteristics and data sources

	Crystal Rig	Aikengall	Hoprigshiels	Ferneylea	Kinegar
State	Operational	Operational	Consented	New	Consented
Capacity (MW)	62	48	9	1.5	5
Data for levels of uncurtailed generation outputs	Historical (SGS)	Historical (SGS)	Scalled Aikengall (SGS)	<u>Data Set-SGS:</u> Scalled Aikengall <u>Data Set-CES:</u> Wind Speed at Hoprigshiels	Scalled Aikengall (SGS)

In this report, the analysis investigates curtailment of Ferneylea against two different sets of input data for this wind farm:

- Data set-CES*: this data set, provided by CES, consists of wind speeds measured at the site of Hoprigshiels wind farm, which Ferneylea is adjacent to. The wind speed data is converted to an unconstrained generation output by using a power-curve specific to the type of turbine planned for of the Ferneylea wind farm, i.e. two E-48 Enercon turbines de-rated to 750kW.

⁵ Note that this excludes uncurtailed levels for Ferneylea wind farm, for which data sets are explained below.

- ii. Data set-SGS: this data set, provided by SGS, uses historic generation output from the Aikengall 48MW wind farm, with a firm connection⁶, and scales it to estimate the unconstrained output of the 1.5MW Ferneylea wind farm, and represents the common practice methods used for ANM curtailment estimates.

The geographical locations of all wind farms are shown in Figure 3.

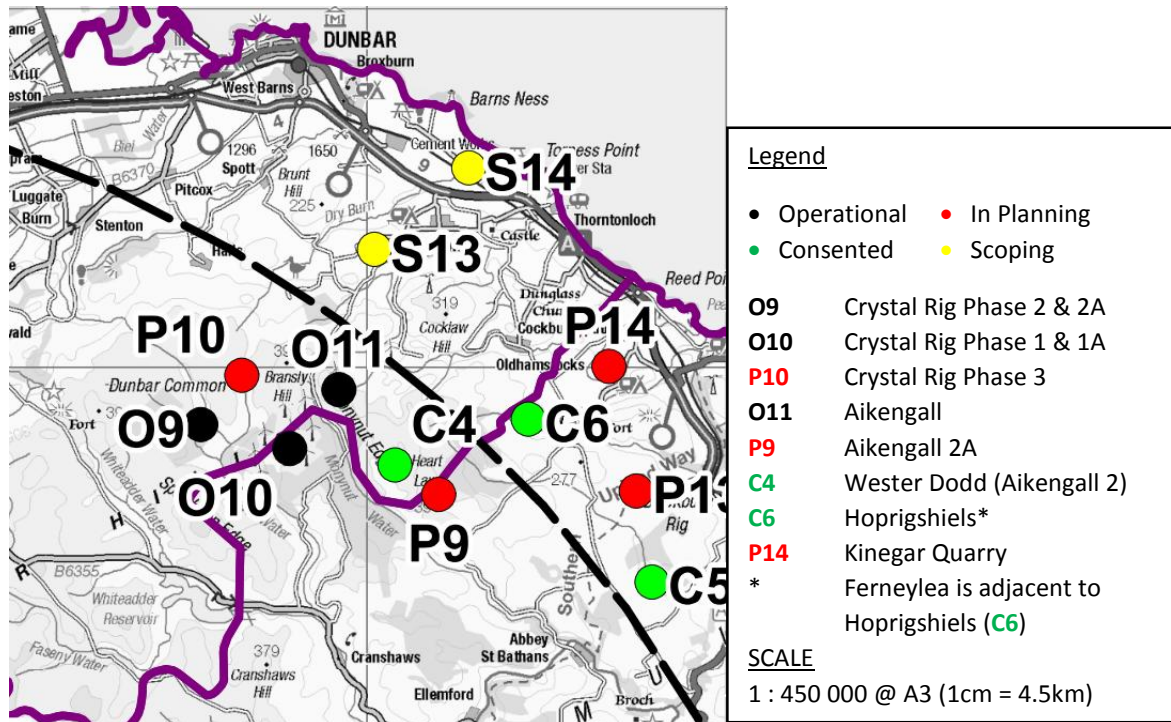

Figure 3: Geographical locations of all wind farms⁷

⁶ Note that Aikengall has a firm connection when both transformers at Dunbar GSP are in operation (see Appendix 1), which is assumed in this study.

⁷ Source: http://www.longparkextensions.co.uk/cms/pagepdf_1294_89.pdf

2.1.2 Methodology, Analysis and Results

An overall analysis of Ferneylea wind farm output curtailment against the Dunbar GSP was carried out for half-hourly time periods during 2011. Figure 4 shows the time-series of uncurtailed generation for Data set-SGS (shown in red) vs. Data set-CES (shown in blue) for two randomly selected fortnights: one in winter and the other in summer in 2011. Although time-series generally show the same trend, there are instances when differences are significant, for example on 4th and 13th of January (for a winter period) as well as 5th and 12th of August (during a summer period).

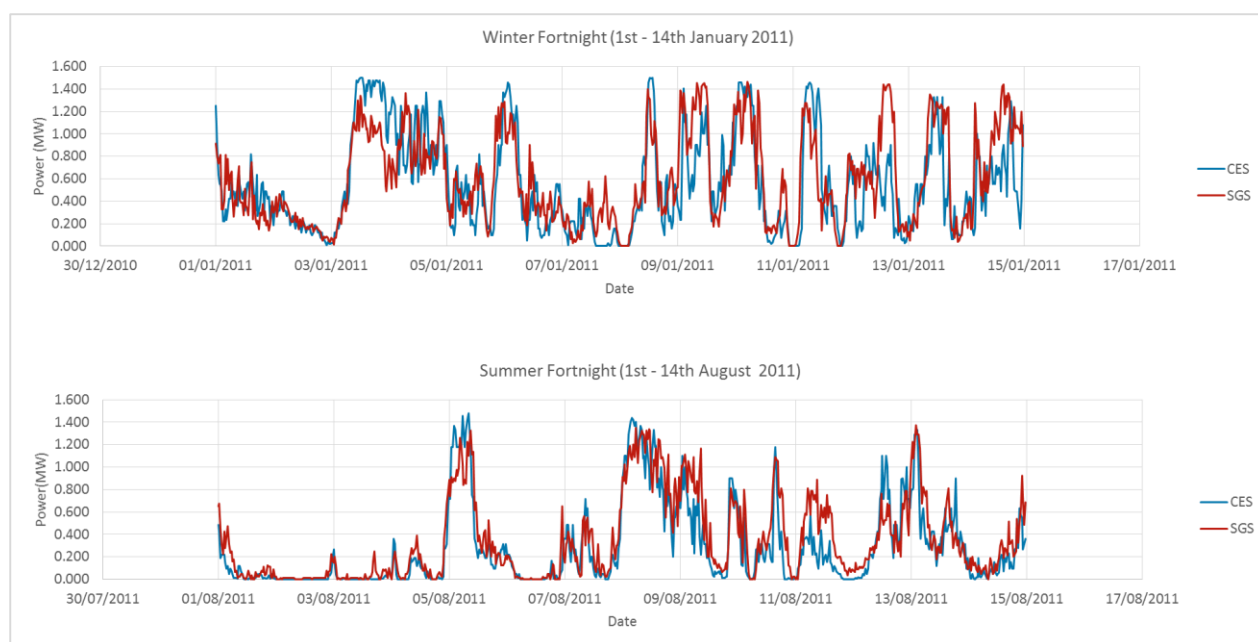

Figure 4: Comparison of Data set-SGS vs. Data set-CES time-series of Ferneylea uncurtailed output

The methodology used here assumes that only the following two thermal constraints are considered⁸: (i) Dunbar GSP constraint and (ii) constraint caused by Aikengall cable (see Figure 19 in Appendix 1) which affects Hoprigshiels. Thus the calculations are based on the following assumptions:

- both transformers at Dunbar GSP are in operation at all times with 108MVA export capacity to the transmission network,
- Hoprigshiels is connected to Dunbar GSP via Aikengall substation by overhead line with 52.17MVA capacity, and
- Viridor (energy from waste plant) is assumed to generate at full capacity at all times.

Note that this analysis does not take account of network effects, including electrical losses, reactive power and voltage fluctuations. A flowchart of the methodology is shown in Appendix A2.1.

⁸ The assumptions are based on consultations with SGS team.

Figure 5 shows comparison of daily curtailment of Ferneylea estimates when using Data set-SGS (shown in red) vs. Data set-CES (shown in blue) for the year 2011.

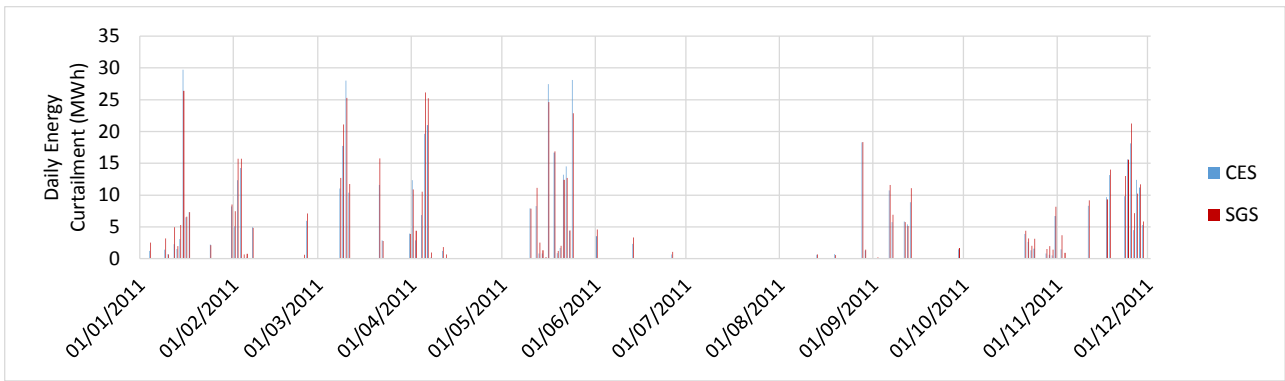

Figure 5: Comparison of Data set-SGS vs. Data set-CES time-series of curtailment of Ferneylea output

The results in Figure 5 show that total estimated curtailment of Ferneylea wind farm output for the year 2011 is 740MWh when Data set-SGS is used, while for Data set-CES estimated value of curtailment is 662MWh. These suggest that the estimated total curtailment at Ferneylea wind farm would be reduced by approximately 10% when the wind farm output is calculated using data which reflect the local wind regime and a type of turbine (as is the case for Data set-CES) rather than assuming that all generation in a 10 – 20 mile radius sees the same wind at the same time.

Daily energy curtailment ranges for the year 2011, for the two input data sets, are shown in Figure 6. It can be seen that only on about 100 days per year there is a curtailment. Furthermore, there are more days with no curtailment when Data set-CES is used. However, it should be noted that the reduced value of curtailment for the Data set-CES is not uniformly translated when comparing number of days for different curtailment ranges. For example, for a curtailment range of [0-5] MWh, there are fewer days for Data set-CES compared to Data set-SGS, while for a curtailment range of [5-10] MWh, it is the opposite.

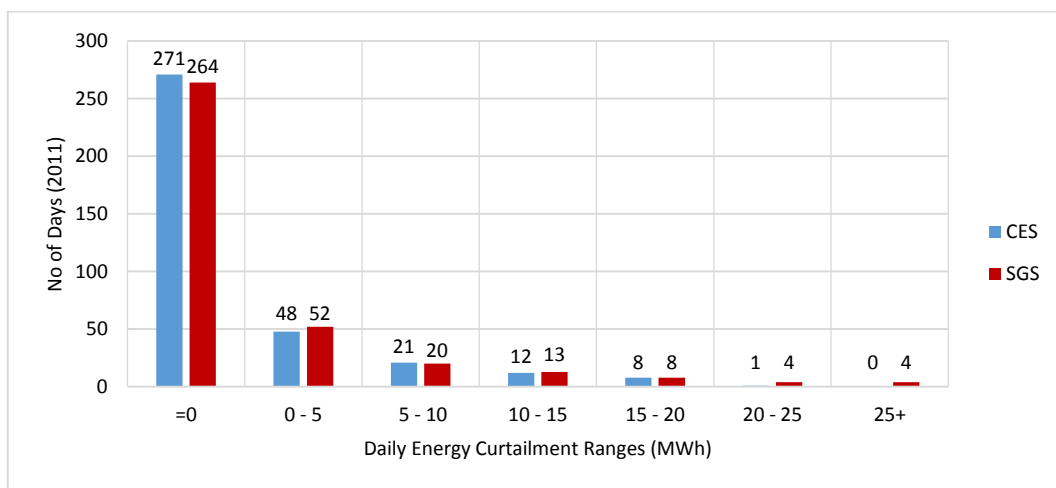

Figure 6: Daily energy curtailment rate of Ferneylea wind farm

At this stage there has been limited time to carry out sensitivity analysis. However, the following qualitative points should be considered when assessing these results:

- If Viridor (energy from waste plant) is running with less than 100% capacity factor, curtailment of Ferneylea output will be reduced.
- It is expected that during times when one of two transformers at Dunbar GSP is out of operation, there would be significantly greater curtailment.
- Geographical diversity of wind generation may affect curtailment, i.e. values of curtailment may differ when the local wind regime and a type of turbine are taken into consideration.

2.2 SOLAR GENERATION ANALYSIS

All BHA properties proposed for PV installations in phase 1 of the LPLB project are electrically connected to one of three GSPs: Berwick, Dunbar and Eccles. Although the smallest number of properties (less than 50) falls under Dunbar GSP, this part of the network is the most critical from the DNO perspective since it is highly export constrained. The proposed PV capacity on these properties exceeds 100kW which is the limit defined by the existing design principles for connecting generation to the LV network⁹ without investigating the impact on the transmission network. Therefore, it is proposed that some of the houses owned by BHA (and in particular those with the new PV installations) will be fitted with devices that can reduce the export of generated electricity from the house by using energy to heat water and store it in a standard domestic hot water tank. It is a new technical solution which is expected to help maintain network operation within proposed security constraints.

The aim of this analysis is to understand the likely generation envelope for the aggregated portfolio of new PV installations under the Dunbar GSP. The capacity factor of PV panels is affected by a number of factors, including an azimuth¹⁰, slope, type and date of installation. It is assumed here that azimuth has the greatest impact on the profile and magnitude of generation from a particular panel as a fraction of its installed capacity.

Note that detailed evaluation of curtailment of PV generation is not part of this analysis, but is proposed for the next stage of the LPLB project. All critical properties considered in this report are located in Cockburnspath, as shown in Figure 7.

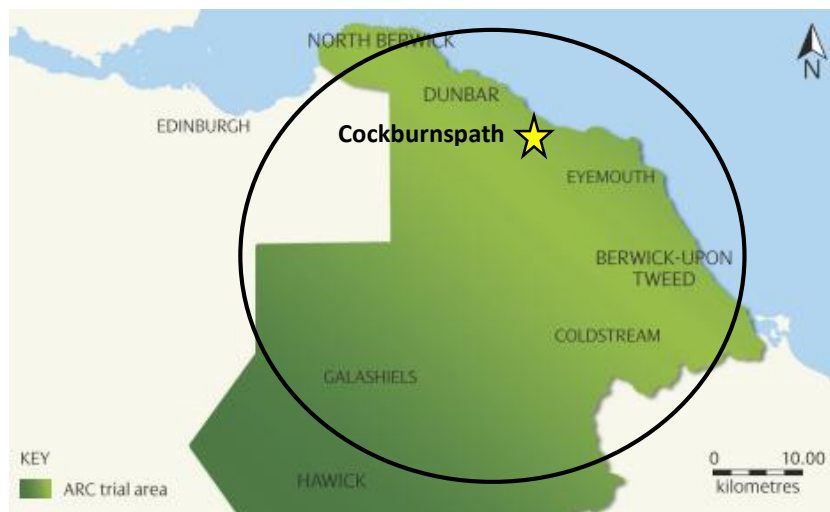

Figure 7: The ARC trial area with location of critical PV panels

BHA plans to install 41 solar panel systems on houses it owns in the village of Cockburnspath in the Scottish Borders. This analysis uses information on the azimuth and total generation capacity of the 41 installations to estimate the ‘envelope of generation’ – that is the maximum output that the aggregation of 41 systems is capable of at each half hour of the day. The envelope of generation can be thought of as the likely aggregated output of the complete portfolio of PV panels in Cockburnspath on a perfectly clear sunny day in the summer.

⁹ Distributed Generation Connection Requirements, SPEN, ESDD-01-005, Issue No 1.

¹⁰ An azimuth angle of a PV panel is the compass direction that the panel faces.

Based on the list of proposed installations provided by BHA, there are 41 houses in Cockburnspath with the total proposed capacity of 144kW spread over 7 different azimuth values. The breakdown of PV installations by proposed azimuth values and their generation capacities is shown in Figure 8.

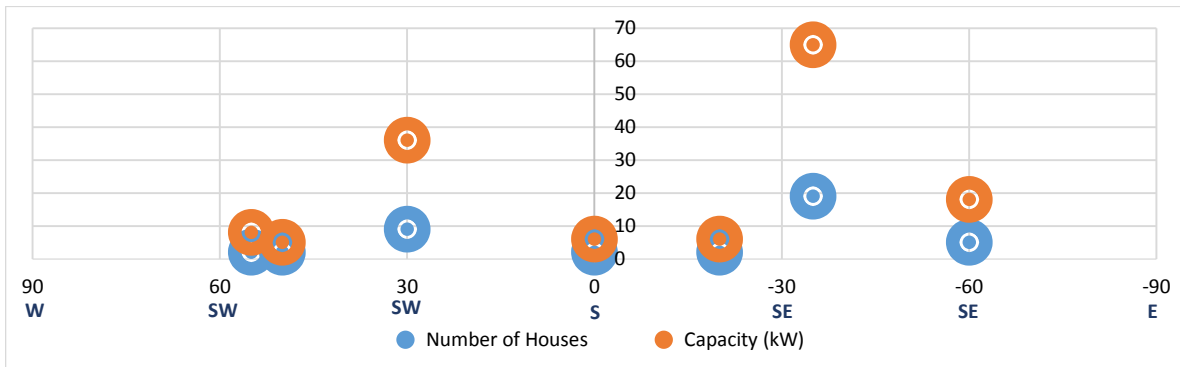

Figure 8: The breakdown of Cockburnspath properties by azimuth and capacity

Note that in Figure 8 negative values of azimuth angles mean ‘Degrees East of South’, i.e. -30 would be 30 degrees east of south or a compass bearing of 150°, while positive values of azimuth angles denote ‘Degrees West of South’, i.e. +30 would be 30 degrees west of south or a compass bearing of 210°. This is illustrated in Figure 9.

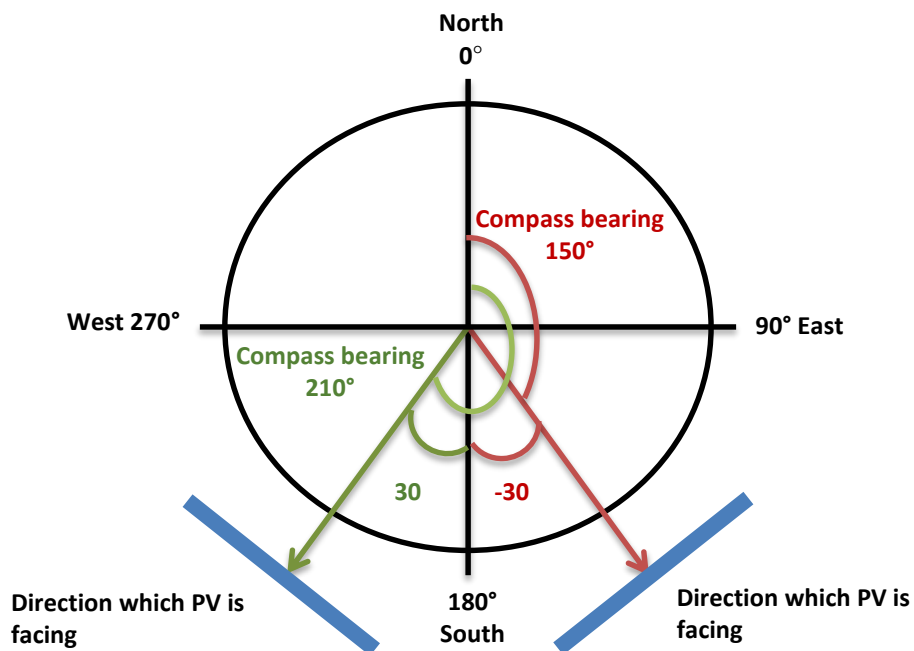

Figure 9: The illustration of PV azimuth

To illustrate locations and azimuths of proposed houses they have been located on Google Maps and indicated in Figure 10.



Figure 10: Cockburnspath properties on Google maps

2.2.1 Input data

In order to estimate a likely generation envelope for the Cockburnspath PV portfolio, historic PV generation data provided by Edison Energy is used. Edison Energy’s online database holds historical solar panel generation for their existing projects in Scotland at more than 1500 properties. Each entry gives an address, and information about the panel, such as installed capacity, azimuth, slope angles, as well as the energy generated in kWh for every half-hourly periods since the system was installed. A sample list of Edison Energy database is shown in Figure 11.

Home - Portal

Welcome, Edison

Previous Next

Show 25 entries

Select all Deselect all Select search Export list Search:

Owner	Serial	Status	Type	MPAN / Desc	Location	Perf	Last read	Last day	Total	Edit?
Berwickshire	11003149	Green	AS230	1800020425556	22 Hawthorn Bank	103%	19-01-15	3,223 kWh	8503,396 kWh	Edit
Berwickshire	11003151	Green	AS230	1800020425547	24 Hawthorn Bank	113%	19-01-15	3,673 kWh	8453,252 kWh	Edit
Berwickshire	11057312	Red	AS230	1800020425538	26 Hawthorn Bank	135%	19-01-15	52,225 kWh	9811,819 kWh	Edit
Berwickshire	11057431	Red	AS230	1800020425398	52 Hawthorn Bank	122%	19-01-15	47,541 kWh	8636,907 kWh	Edit
Berwickshire	11183460	Red	AS230	1800020425370	58 Hawthorn Bank	48%	19-01-15	17,328 kWh	6911,812 kWh	Edit
Berwickshire	11051960	Red	AS230	1800034512768	29 Parkside	108%	19-01-15	16,575 kWh	7046,099 kWh	Edit
Berwickshire	11003150	Green	AS230	1800034512759	30 Parkside	117%	19-01-15	1,592 kWh	7358,537 kWh	Edit
Berwickshire	11057391	Red	AS230	1800034512740	31 Parkside	105%	19-01-15	15,304 kWh	7057,834 kWh	Edit
Berwickshire	11051967	Red	AS230	1800034512730	32 Parkside	98%	19-01-15	15,141 kWh	6690,852 kWh	Edit
Berwickshire	11057449	Red	AS230	1800034512721	33 Parkside	88%	19-01-15	13,765 kWh	7036,813 kWh	Edit
Berwickshire	11051964	Red	AS230	1800034536095	35 Parkside	74%	19-01-15	11,555 kWh	6845,383 kWh	Edit
Berwickshire	11057307	Red	AS230	1800034512703	36 Parkside	66%	19-01-15	10,386 kWh	5797,47 kWh	Edit
Berwickshire	11057400	Red	AS230	1800034512698	37 Parkside	66%	19-01-15	10,331 kWh	6607,991 kWh	Edit
Berwickshire	11057350	Green	AS230	1800034536086	38 Parkside	63%	19-01-15	1,008 kWh	6071,329 kWh	Edit
Berwickshire	11003152	Green	AS230	1800020647092	20 Prior Hill	130%	19-01-15	1,486 kWh	5280,974 kWh	Edit

Figure 11: Edison Energy online database

In order to estimate the ‘envelope of generation’ of the Cockburnspath PV portfolio, information on the maximum output achieved during each half hour of the day for existing panels with approximately the same azimuths as those proposed for Cockburnspath were obtained. For each of the 7 azimuth groups of the Cockburnspath PV portfolio, existing panels with approximately the same azimuth values were randomly

selected from a subset of PV installations that had at least one year worth of data (up till 2013). In total 32 historic PV panels were selected and Figure 12 illustrates the historic output of a particular house.



Figure 12: Daily break down of a particular PV panel for a given period of time

For each of the 32 PV installations, values of half-hourly energy generated (in kWh) throughout the year 2013 were obtained from the database. Note that the number of time-series, i.e. the number of days with available readings, varies for each installation as there are days when no data is available. This can be due to either lost communication connection with the meter or the system being switched off.

2.2.2 Methodology and Analysis

The methodology for estimating the generation envelope for the new PV portfolio includes the following steps:

1. Historic data processing, which identifies and removes unreliable data. All the installations with less than 100 days of good quality data were removed, as they were deemed unreliable and could lead to inaccurate estimation of PV generation outputs. This step reduced a number of existing PV panels used for further analysis to 28.
2. Accounting for Summer Savings Time change, where data for the periods of Summer Time (BST) is converted to Greenwich Mean Time (GMT).
3. Determining the maximum PV output, where the maximum historic half-hourly outputs for all of the 28 existing panels (determined in step 1) were found for each of the 48 half hour periods within a day. These are used to estimate the maximum output, or the individual generation curve for each PV installations, shown in Figure 13.

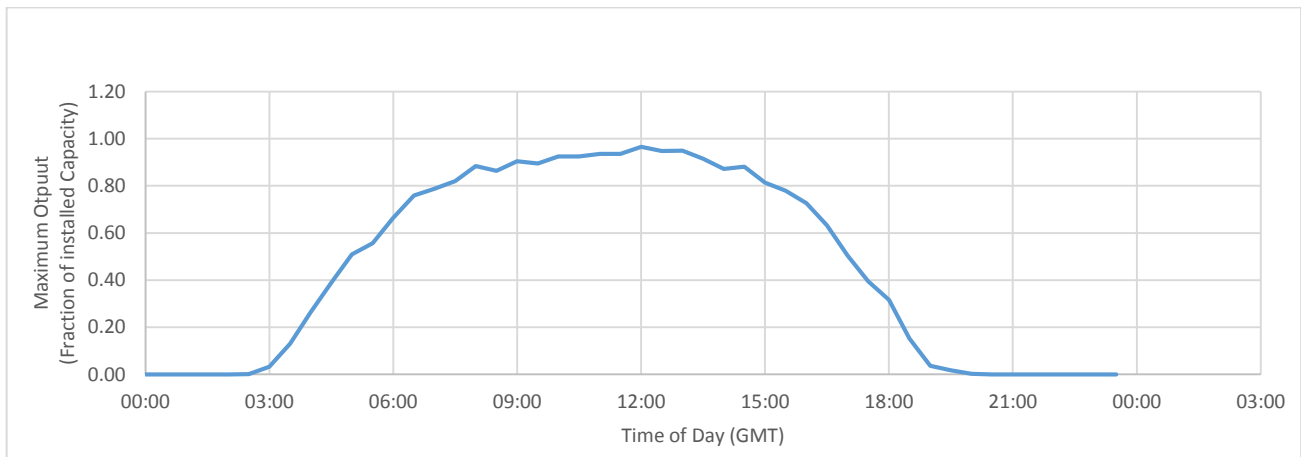

Figure 13: The general maximum output curve for any of the existing PV installations

4. Determining the maximum PV output for groups of houses at specified azimuth intervals. The 7 azimuth groups at Cockburnpath are: -60, -35, -20, 0, 30, 50, and 55. To estimate the maximum outputs of panels at these azimuths the 28 existing PV installations are clustered according to their azimuth values, as indicated in Figure 14.

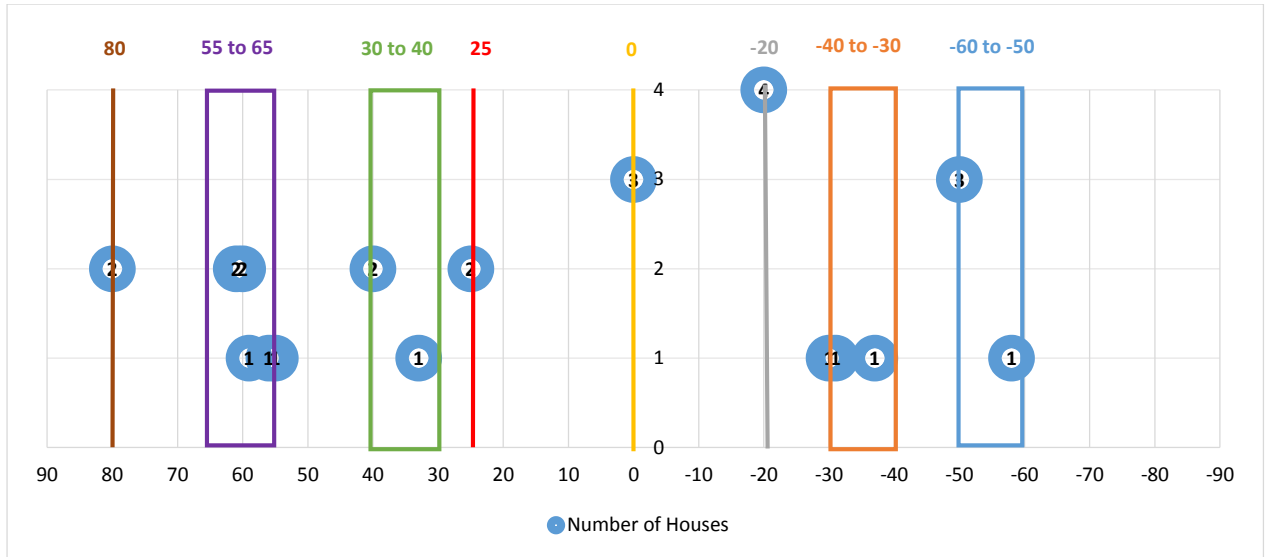

Figure 14: Clustering of existing 28 PV installations by azimuth

Figure 14 shows the division of the existing 28 PV panels into 8 groups with the indicated azimuth values as indicated in Figure 14, and also shown in legend in Figure 15. For each of these 8 azimuth clusters, the individual generation envelopes for installations within that range are combined to give an overall generation envelope for that azimuth group, with the results shown in Figure 15. Each of the curves corresponding to one of the azimuth groupings is below the general maximum output curve (Figure 13).

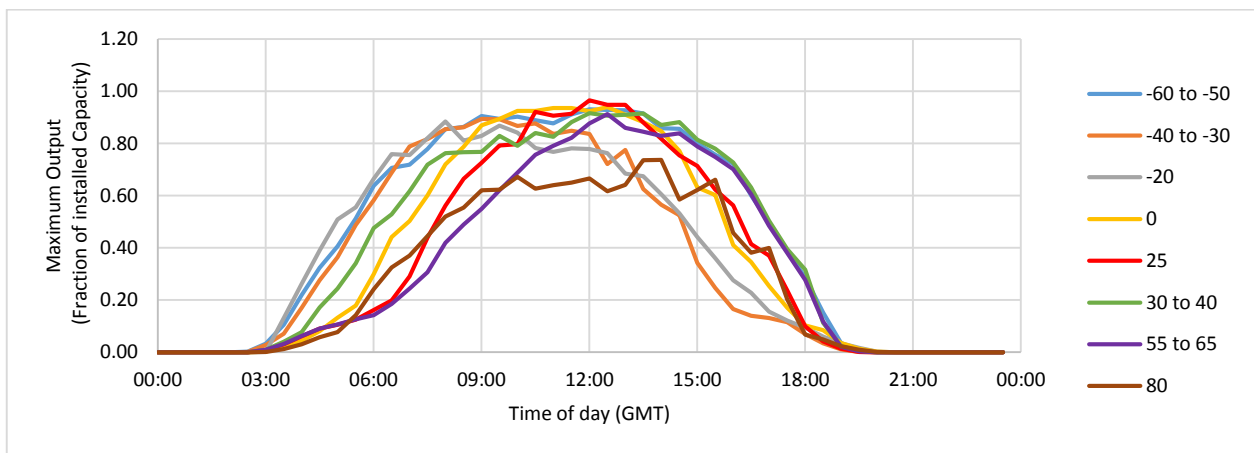

Figure 15: The maximum historic output of each azimuth group across the day

As expected, panels facing east (negative azimuth values) have their maximum output in the morning, while panels facing west (positive azimuth values) have their maximum output in the afternoon. There are some anomalies in the results shown in Figure 15 which suggests that the panels orientated at 20°E (i.e. a line for value -20) outperform all of the others in the early morning, even the most easterly-facing (-60 to -50 line) units, which, contrary to expectations, are among the best-performing in the evening. The most likely reasons for this might be the inconsistent

information of azimuth angles on the Edison Energy database, the influences of the age and type of the system, and variations in slope angle. Figure 16 shows an example of the mismatch information of one system found by UoS where an azimuth value of -58 suggests that the PV panels is facing South West, rather than South East as Google map (Figure 16) shows.



Figure 16: Properties with mismatch information on Google maps

An important part of further work on this project will be to confirm the accuracy of azimuths for the existing fleet of PV panels used in the analysis and sensitivity analysis on the effect of system age, type and slope angle.

5. Estimation of likely generation envelope of Cockburnspath PV panels, where for each proposed Cockburnspath installation one of the maximum output curves determined in the previous step, (and which is closest to its azimuth value), is assigned. The envelope of generation for the particular installation is then multiplied by its proposed capacity to give an envelope of maximum generation for that installation. Finally, estimated half-hourly outputs of all proposed PV installations are added to obtain an envelope of maximum generation for all Cockburnspath PV panels.

The flowchart of the proposed methodology is shown in Appendix A2.2.

2.2.3 Results

The estimated maximum generation envelope for the Cockburnspath PV portfolio is obtained using the above methodology and shown in Figure 17. From the perspective of the DNO, output at the level shown represents the most onerous conditions – generation for all PV panels on a perfectly clear and sunny summer day. The results suggest that the maximum estimated output for the proposed 41 Cockburnspath installations is 126kW, which occurs at 12 GMT. That is around 88% of the proposed capacity of 144kW. The highlighted part of the day in Figure 17 is time when total PV output may exceed the design limit of 100kW; this is between 07:00 – 14:30 GMT. Note that it is indicated the proposed installed capacity will never be reached.

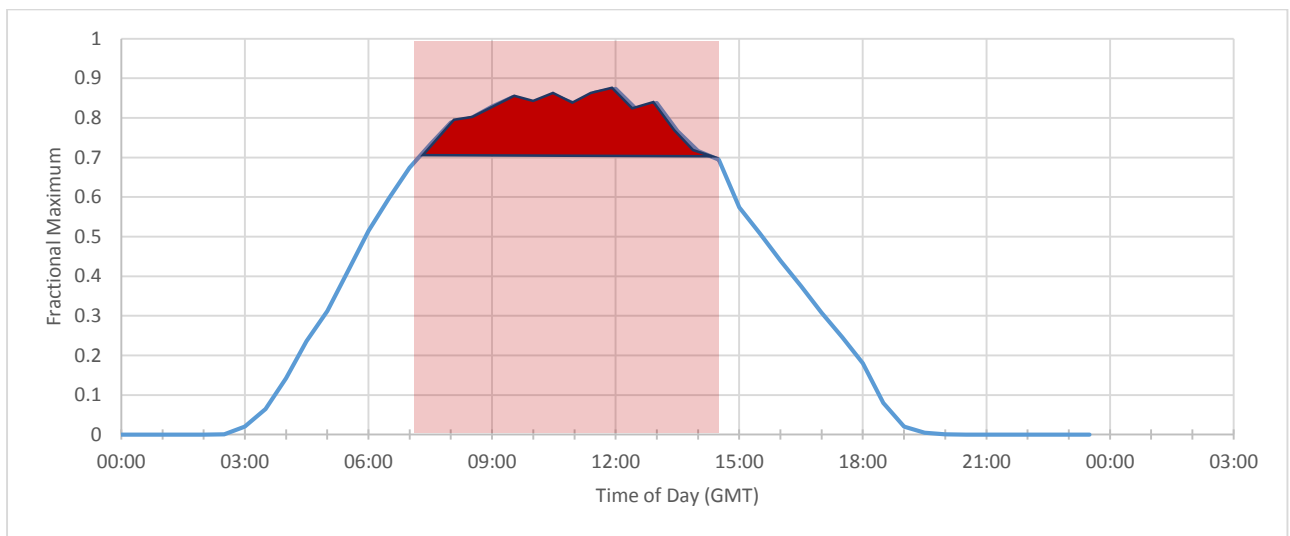

Figure 17: Likely maximum generation envelope for Cockburnspath solar panels

To obtain a grid connection for the Cockburnspath PV portfolio, its export onto the local distribution network may need to be limited to less than 100kW at all times. There are two ways this can be achieved: firstly, by curtailing the generation when the total PV outputs would otherwise exceed 100kW; secondly, by using demand side response behind the electricity meters to which the PV panels are connected. The area of dark solid shading in Figure 17 shows the total energy that would need to be either curtailed or used through DSM if the portfolio generation follows the calculated envelope.

Figure 18 presents the results of the ‘excess energy’ calculation for all export threshold levels. Each point represents the excess of energy (summed at half-hourly level) for different levels of maximum DG connections permitted by design (currently set to 100kW). The red circle highlights the threshold of 100kW export which is calculated as 121kWh on a sunny summer day. This energy would either need to be curtailed or used locally (e.g. via heat pumps) if the output of the PV group were to be limited below the installed capacity. On any particular day the generation profile for the portfolio will fall below the envelope, and the energy required to be curtailed or managed will be less.

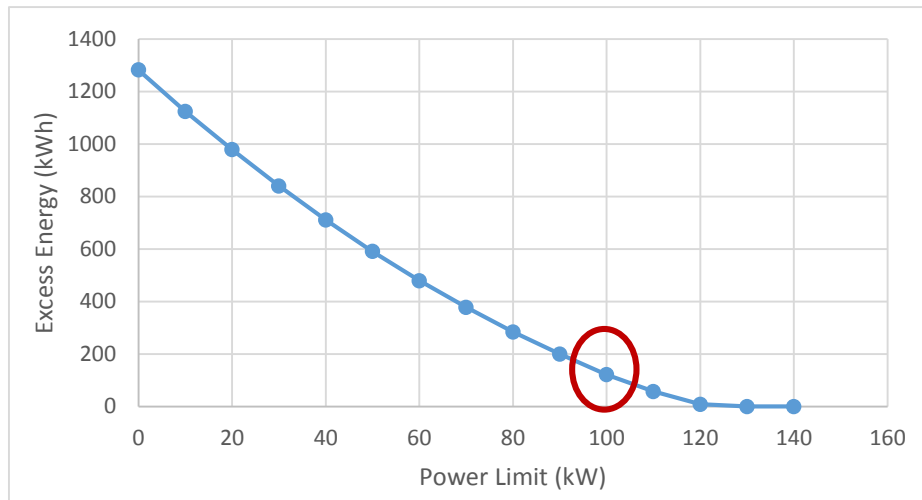

Figure 18: Maximum energy involved in limiting output of Cockburnspath solar panels to 100kW

3 SUMMARY AND CONCLUSIONS

The work presented in this report describes the background analysis carried out by the University of Strathclyde to support the *Local Power, Local Benefit* project. The following has been carried out:

- Evaluation of wind farm curtailment: estimation of wind farm outputs and curtailment for the proposed Ferneylea wind farm using two approaches, by neglecting an influence of possible PV installations.
- A methodology for estimation of a likely generation envelope for the new PV installations, without any possible curtailment analysis.

The report presents tentative results based on a year period of data. The overall results and conclusions are listed below:

- **Wind farm curtailment analysis:**
 - It is expected that Ferneylea wind farm would likely be curtailed by 662MWh and 740MWh, for Data set-CES and for Data set-SGS, respectively, in the study year.
 - Curtailment is not evenly spread throughout the year. There are likely to be $\frac{3}{4}$ of the year with no curtailment and 21 (for Data set-CES) or 29 (Data set-SGS) days in which curtailment exceeds 10MWh.
 - Geographical diversity of the wind resource generation will affect curtailment estimates, i.e. values of curtailment may differ when using local wind speed profiles and different type of turbine.
- **Solar generation analysis:**
 - The maximum estimated envelope of output for the proposed 41 Cockburnspath PV portfolio occurs at 12 GMT and it is 126kW which is 88% of proposed capacity of 144kW.
 - The proposed installed capacity will never be reached.
 - If the aggregated output of Cockburnspath portfolio is limited to 100kW (70% of proposed capacity) under the existing design principles, the maximum excess energy is identified as 121kWh on a sunny summer day. This excess energy is equivalent to 3kWh per each PV installation of Cockburnspath portfolio, and is enough to heat 50 litres of water.
 - This excess energy could be either curtailed or used behind the meter – that is within the houses to which the PV is connected.

Further work will carry out wind curtailment and PV output analysis for a longer period of time while also including other wind farms and PV panels before drawing firm conclusions. Significantly greater certainty regarding data on the historic PV panels will be required before finalising the conclusions. In addition, a further area to explore is a detailed evaluation of the curtailment of PV generation as well as a possible influence that wind farms and PV panels can have on each other.

APPENDIX 1: THE SIMPLIFIED LPLB MODEL

This appendix shows a simplified schematic diagram of a model of the LPLB project indicating connections of renewable generation within Dunbar GSP. With two 60MVA transformers at Dunbar GSP, as shown in Figure 19, total export limit is 120MVA and ANM scheme takes effect at 90% loading, i.e. at 108MVA.

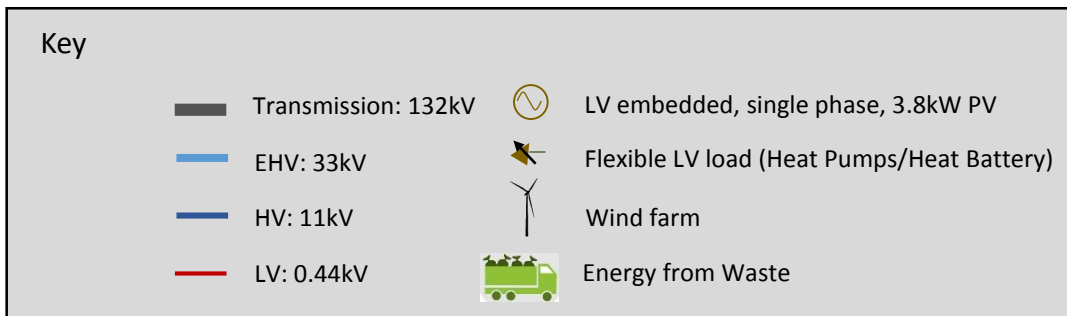
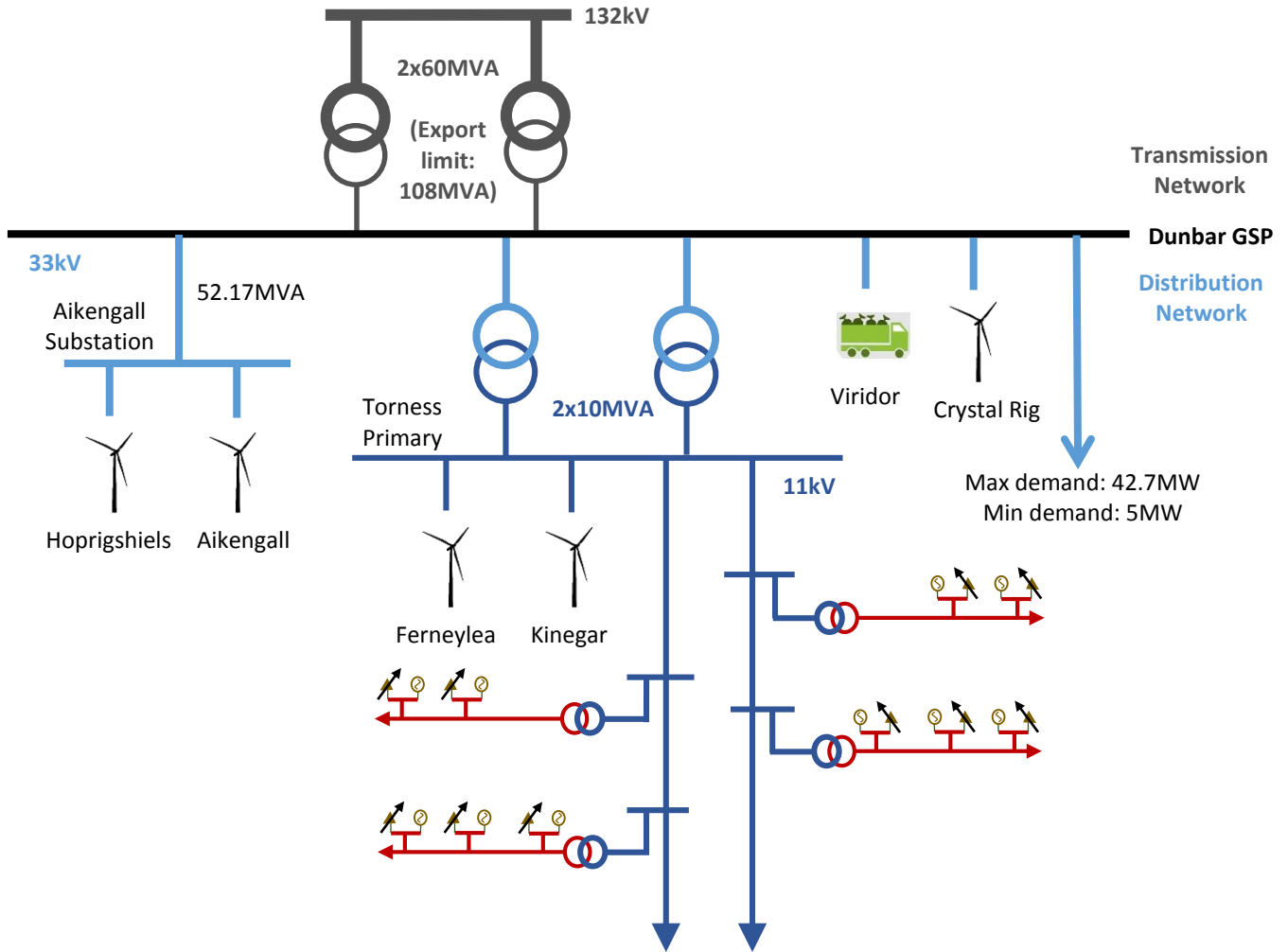

Figure 19: The LPLB project model

APPENDIX 2: SUMMARY OF BACKGROUND ANALYSIS FLOWCHARTS

During the background analysis for the LPLB project, the University of Strathclyde used algorithms coded in Matlab and Excel and this appendix provides their flowcharts.

A2.1 – WIND FARM CURTAILMENT ANALYSIS

An overall analysis of Ferneylea wind farm output curtailment against the Dunbar GSP was carried out for half hour time periods for a year 2011 (indicated with N in Figure 20). The analysis involves two constraints, a GSP thermal constraint and a constraint caused by Aikengall cable constraint. The flowchart of the analysis is shown in Figure 20.

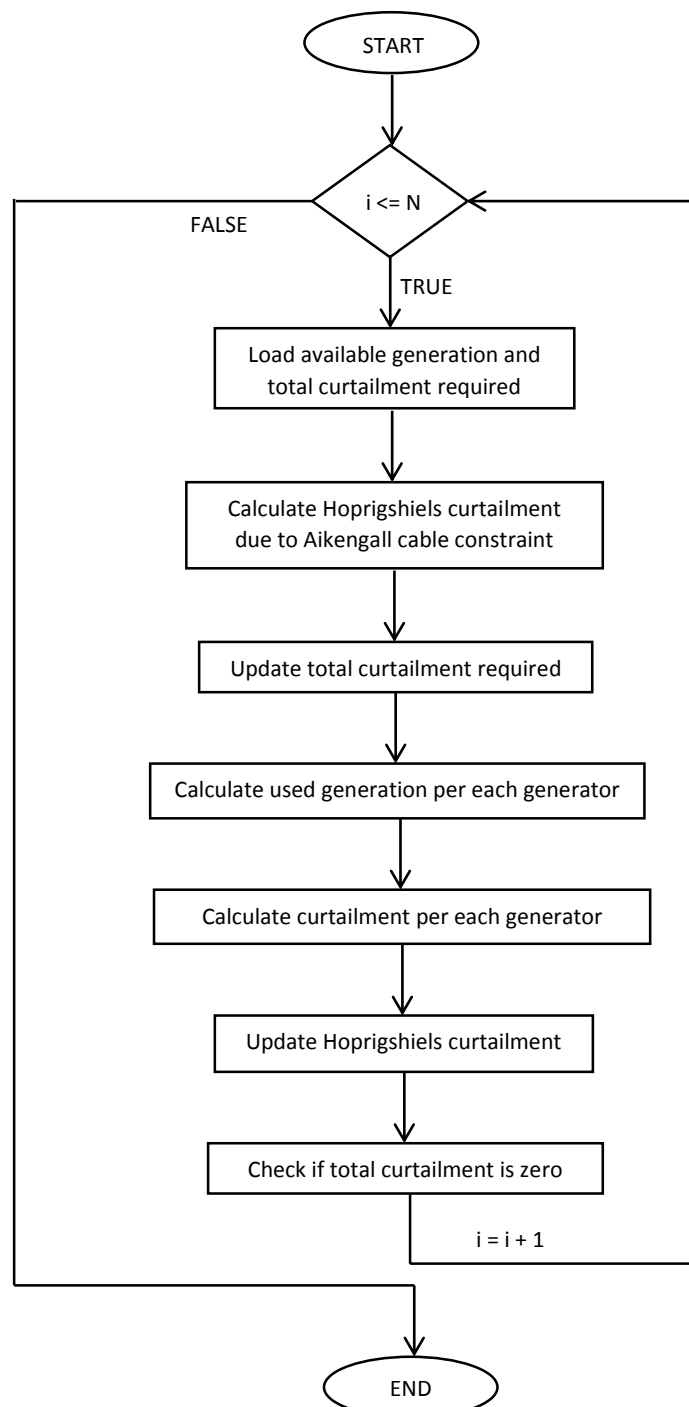

Figure 20: Wind farm curtailment analysis

A2.2 – SOLAR GENERATION ANALYSIS

The solar data analysis to estimate a likely generation envelope for the new PV installations is shown in Figure 21.

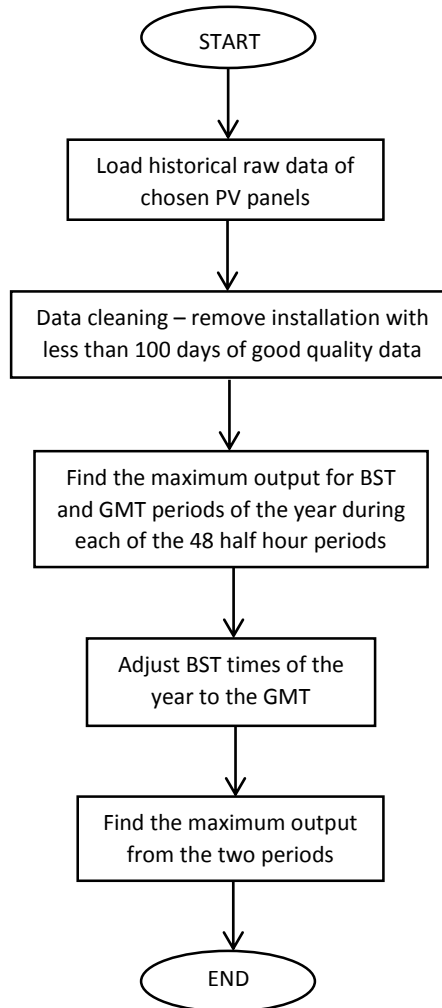

Figure 21: Solar data analysis